



Union Special
INDUSTRIAL SEWING EQUIPMENT

STYLES

**ADJUSTING INSTRUCTIONS AND
ILLUSTRATED PARTS LIST**

**63400A
63400B**

**STREAMLINED HIGH SPEED LOCKSTITCH
MACHINES**

**CATALOG
NO. 121M**

**SECOND
EDITION**

**SECOND EDITION
© 1961**

PRINTED 1996 IN USA

INFORMATION SUBJECT TO CHANGE WITHOUT NOTICE

© UNION SPECIAL CORPORATION ALL RIGHTS RESERVED IN ALL COUNTRIES.

IDENTIFICATION OF MACHINES

Each UNION SPECIAL machine is identified by a Style number which is stamped into the name plate on the machine. Style numbers are classified as standard and special. Standard Style numbers have one or more letters suffixed, but never contain the letter "Z". Example: "Style 63400 A". Special Style numbers contain the letter "Z". When only minor changes are made in a standard machine, a "Z" is suffixed to the Standard Style number. Example: "Style 63400 AZ".

Styles of machines similar in construction are grouped under a class number which differs from the style number, in that it contains no letters. Example: "Class 63400".

APPLICATION OF CATALOG

This catalog applies specifically to the Standard Styles of machines as listed herein. It can also be applied with discretion to some Special Styles of machines in this Class. Reference to direction, such as right, left, front, back, etc., are given from the operator's position while seated at the machine. Operating direction of the handwheel is toward the operator.

STYLES OF MACHINES

High Speed Streamlined Long Arm Lockstitch Machines, One Needle, Light, Medium and Heavy Duty, Drop Feed, Rotary Hook, Horizontal Hook Shaft, Push Button Stitch Regulator, Stitch Length Indicator, One Reservoir Enclosed Automatic Lubricating System, Head Oil Siphon, Adjustable Hook Oil Control, Automatic Head Oiling, Needle Bearing Adjustable Feed Eccentric, Needle Bearings for Take-up Lever and Needle Bar Driving Link, Feed Timing on Lower Main Shaft, Maximum Work Space to Right of Needle Bar 11 1/8 Inches.

*63400 A For miscellaneous plain seaming operations on light and medium weight work, 1 9/64 inch needle bar travel. Type 183 GXS or 183 GYS needle. Specify presser foot, throat plate, feed dog, stitches per inch, thread size, needle type and size, attachments and guides.

63400 B For miscellaneous plain seaming operations on medium and medium heavy weight work, 1 13/64 inch needle bar travel. Type 180 GXS or 180 GYS needle. Specify presser foot, throat plate, feed dog, stitches per inch, thread size, needle type and size, attachment and guides.

* DISCONTINUED - In most instances, component parts can be ordered for customer repair.

NEEDLES

Each needle has both a type and size number. The type number denotes the kind of shank, point, length, groove, finish and other details. The size number, stamped on the needle shank, denotes largest diameter of the blade measured across the eye. Collectively, the type number and the size number represent the complete symbol.

Needle Type 180 GXS or 180 GYS is recommended for Style 63400 B and needle Type 183 GXS or 183 GYS is recommended for Style 63400 A. Their description and the sizes available are listed below.

<u>Type No.</u>	<u>Description and Sizes</u>
180 GXS	Round shank, round point, lockstitch, short length, ball eye, single groove, wide angle groove, struck groove, deep spot, ball point, chromium plated - sizes 075/029, 080/032, 090/036, 100/040, 110/044, 125/049, 140/054, 150/060.
180 GYS	Round shank, round point, lockstitch, short length, ball eye, single groove, wide angle groove, struck groove, deep spot, chromium plated - sizes 075/029, 080/032, 090/036, 100/040, 110/044, 125/049, 140/054, 150/060.
183 GXS	Round shank, round point, lockstitch, extra short length, ball eye, single groove, wide angle groove, struck groove, deep spot, ball point, chromium plated - sizes 025, 075/029, 080/032, 090/036, 100/040, 110/044.
183 GYS	Round shank, round point, lockstitch, extra short length, ball eye, single groove, wide angle groove, struck groove, deep spot, chromium plated - sizes 028, 080/032, 090/036, 040, 044.

NEEDLES (Continued)

To have needle orders promptly and accurately filled, an empty package, a sample needle, or the type and size number should be forwarded. Use description on label. A complete order would read: "1000 Needles, Type 180 GXS, Size 080/032".

Selection of proper needle size should be determined by the size of the thread used. Thread should pass freely through the needle eye in order to produce a good stitch formation.

SELECTING THE SIZE OF THE NEEDLE

The strength requirement of the seam produced is largely dependent upon the size of the thread employed.

The following table shows the preferred size of needle for a given size and kind of thread. The choice, however, should give consideration to factors referred to above, which may dictate the selection of a needle size slightly larger or smaller than the size specified.

<u>Cotton Thread Size</u>	<u>Mercerized Thread Size</u>	<u>Needle Size</u>
0	-	150/060
30	B	140/054 to 150/060
36	A	125/049 to 140/054
40	A	110/044 to 125/049
50	0	110/044 to 125/049
60	00	100/040 to 110/044
70	000	090/036 to 100/040
80	0000	080/032 to 090/036
90	0000	080/032 to 090/036
100	-	075/029 to 080/032

IDENTIFYING PARTS

Where the construction permits, each part is stamped with its part number. Parts too small for a complete catalog stamping are identified by letter symbols which distinguish one part from another that is similar in appearance.

Part numbers represent the same part, regardless of the catalog in which they appear.

IMPORTANT! ON ALL ORDERS, PLEASE INCLUDE PART NAME AND STYLE OF MACHINE FOR WHICH PART IS ORDERED.

ORDERING OF REPAIR PARTS

ILLUSTRATIONS

The arrangement of this catalog is to facilitate easy and accurate ordering of Class 63400 replacement parts.

Six exploded view plates cover the Standard Styles listed in this catalog. Each plate presents a sector of the machine, parts being aligned as in their assembled position. Small keyline views show by a blackened area exactly where the parts being discussed fit in the assembled machine. On the page opposite the illustration will be found a listing of the parts with their part numbers, descriptions and the number of pieces required in the particular view being shown.

Numbers in the first column are reference numbers only, and merely indicate the position of the part in the illustration. Reference numbers should never be used in ordering parts. Always use the part number listed in the second column. Each exploded view plate carries a reference number for each part for sale.

Sub-assemblies, which are sold complete, or by separate part, are in a bracket or a solid line box on the picture plate. Component parts of sub-assemblies, which can be furnished for repairs, are indicated by indenting their descriptions under the description of the main sub-assembly. Example:

20	29126 DD	Feed Driving Eccentric and Connecting Rod Assembly -----	1
21	61438 B	Feed Drive Eccentric Connecting Rod -----	1
22	660-225	Needle Bearing -----	1
23	88	Set Screw -----	1

In those cases where a part is common to all of the machines covered by this catalog, no specific usage will be mentioned in the description. However, when the parts for the various machines are not the same, the specific usage will be mentioned in the description, and, if necessary, the difference will be shown in the illustration.

At the back of the book will be found a numerical index of all the parts shown in this book. This will facilitate locating the illustration and description when only the part number is known.

USE GENUINE REPAIR PARTS

Success in the operation of these machines can be secured only with genuine UNION SPECIAL Repair Parts as furnished by the Union Special Corporation, its subsidiaries and authorized distributors. They are designed according to the most approved scientific principles, and are made with utmost precision. Maximum efficiency and durability are assured.

TERMS

Prices are strictly net cash and subject to change without notice. All shipments are forwarded f.o.b. shipping point. Parcel Post shipments are insured unless otherwise directed. A charge is made to cover the postage and insurance.

INSTALLING

CAUTION! When unpacking, DO NOT lift machine out of box by placing one hand on handwheel. Using both hands on bed casting, lift gently.

Before leaving factory, each UNION SPECIAL machine is sewed off, inspected and carefully packed. After the machine and accessories have been removed from the packing box, the following steps should be followed:

PREPARATION OF MACHINE FOR INSTALLATION

A bag of assembly parts, consisting of one frame thread eyelet, one eyelet attaching screw, one extra bobbin, two hinge studs, and two screws for holding miscellaneous attachments to the bed plate, is packed with each machine.

Insert hinge studs in holes provided for them in rear of cloth plate. Assemble the upper frame eyelet (A, Fig. 2).

STANDARD ACCESSORIES

Included also with each machine is a box of STANDARD ACCESSORIES--containing one bobbin winder assembly, the machine mounting frame, one oil drain jar and its clamp spring, one knee lifter assembly and its rubber pad, bed positioning spring and screw, four isolator pads and clips, and one machine rest pin. These parts are essential when setting up the machine.

TABLE TOPS

Lockstitch machines are installed in table tops, prepared with cut-out, so that the bed plate is FLUSH with the top of the machine mounting frame.

MACHINE MOUNTING FRAME INSTALLATION

On a suitable tableboard, place machine mounting frame (21393 N) in the machine cut-out with the hinge lugs to the rear (Fig. 1). Insert the countersunk wood screw through left hinge pad and tighten securely. Assemble bed positioning spring (63474 A) over right hinge pad; insert round head wood screw and tighten securely. Assemble the retaining plate (21393 R) to outside front of pan section, as shown, and snug up nuts lightly.

Place sewing head in the frame mounting, and after being sure there is about 1/16 inch clearance between the cloth plate edge and the frame sides, rap the retaining plate smartly upward with a hammer to insure a good grip on the underside of the board and tighten locking nuts securely.

Tip machine back against rest pin, and assemble the knee press assembly as shown. All end play of the cross shaft should be taken up by the cone bearings, but must not bind.

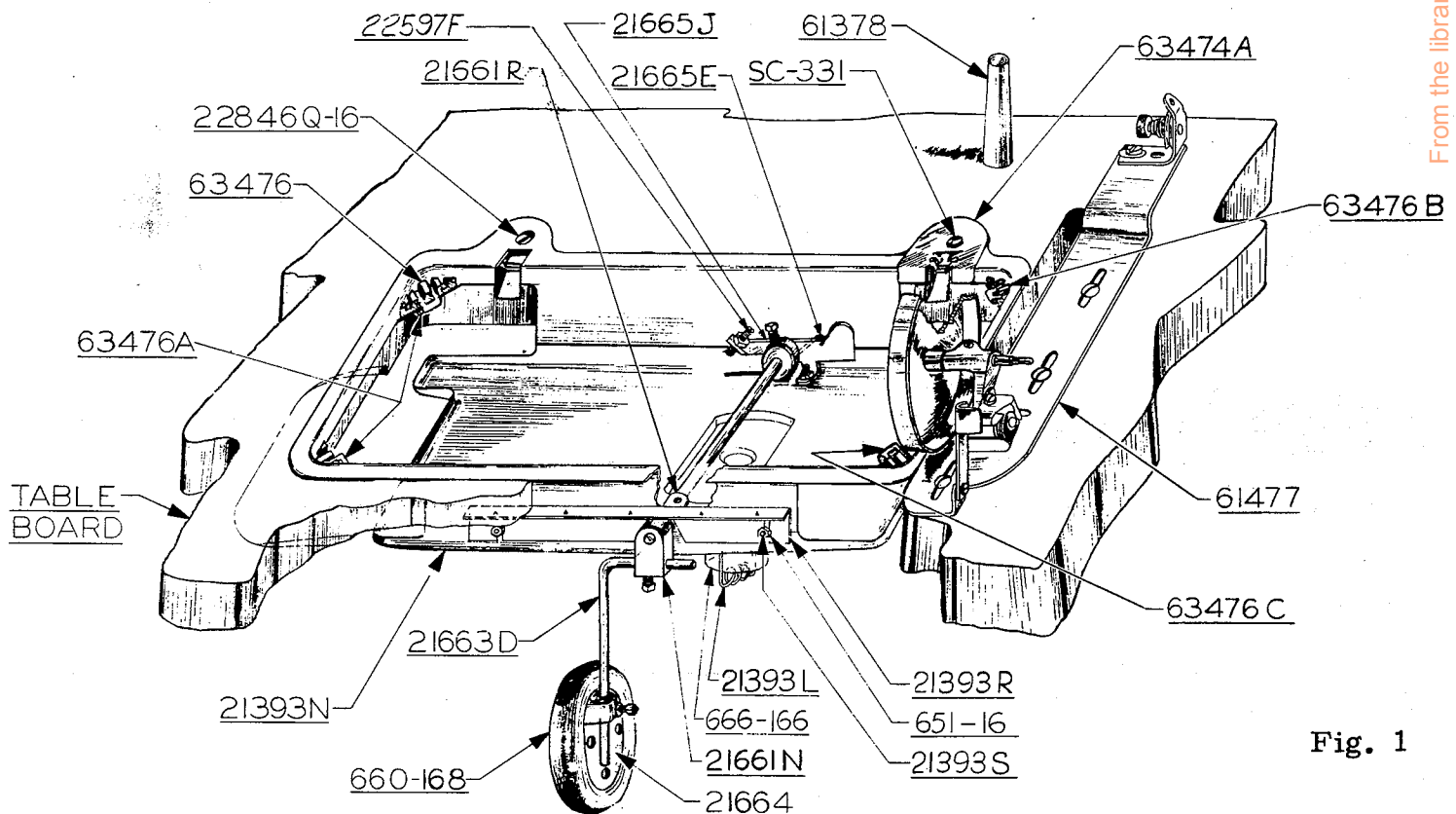

Fig. 1

INSTALLING (Continued)

MACHINE MOUNTING FRAME INSTALLATION (Continued)

Before the machine is put into production, the bell crank (21665 J) of the knee lifter rod should be adjusted. The left stop screw (22597 F) should be set so that the maximum lift of the presser bar and its parts do not interfere with moving parts within the head. This may be done by setting the stop screw so that the presser bar raises approximately $5/16$ inch.

BOBBIN WINDER

The bobbin winder should be secured to the table top so that its pulley will be located directly in front of the sewing machine belt and will bear against the belt when in operation. The base of the winder has two elongated attaching holes, which allow the mechanism to be moved closer to or farther away from belt as needed. The pulley of the winder, when in operation, should exert only enough pressure against the belt to wind the bobbin. Regulation and operation of the bobbin winder is described under "Winding the Bobbin", under OPERATOR'S INSTRUCTIONS.

BELTS

These machines are equipped to use either #1 "Vee" or round belts.

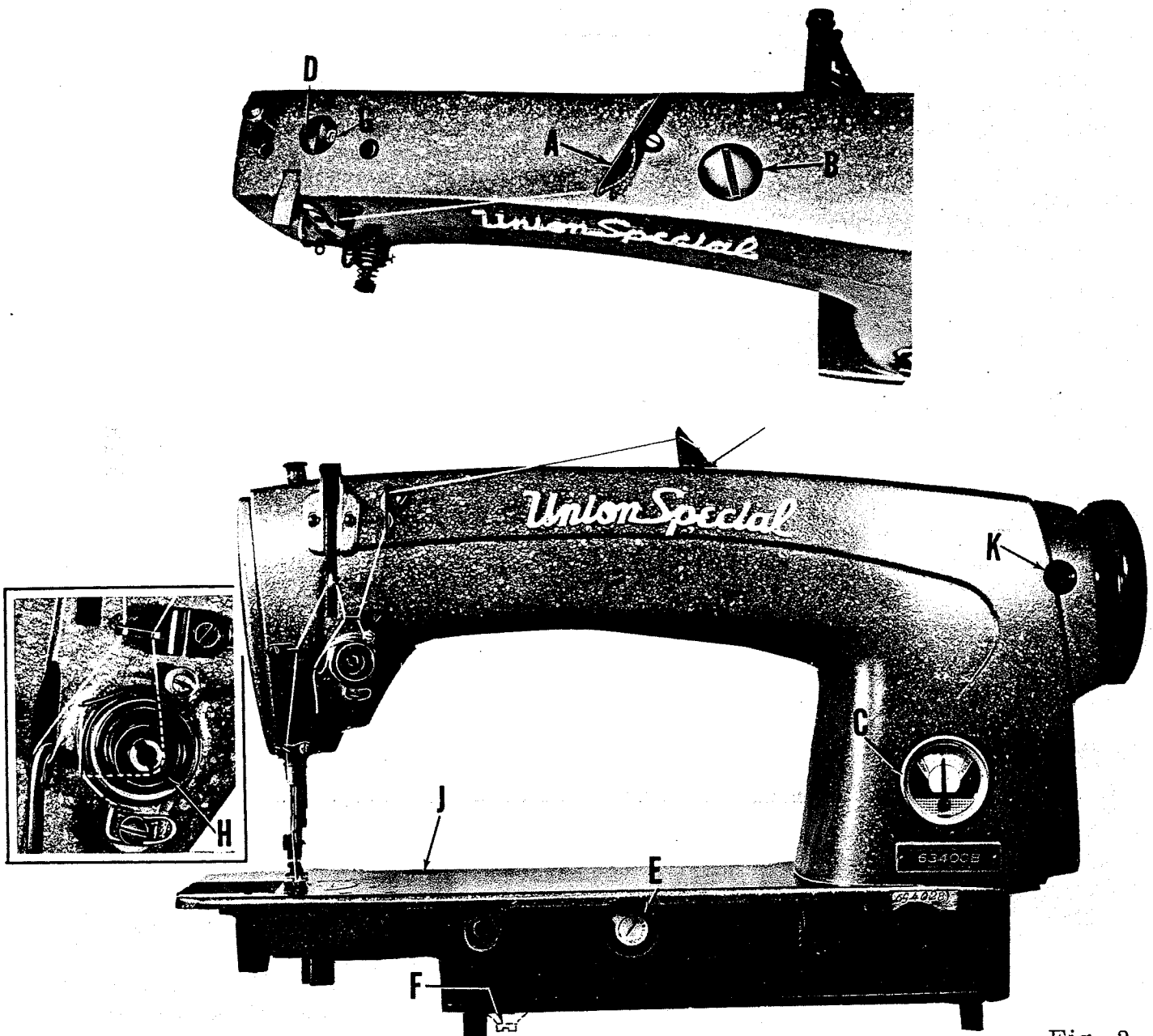

Fig. 2

LUBRICATION

CAUTION! Oil has been drained from the main reservoir before shipment and the reservoir must be filled before starting to operate.

Lubricate machine thoroughly, in accordance with instructions which follow, and run slowly for several minutes to distribute the oil to the various parts. Full speed operation can then be expected without damage.

RECOMMENDED OIL

Use a stainless water-white straight mineral oil of a Saybolt viscosity of 90 to 125 seconds at 100° Fahrenheit in the main reservoir. This is equivalent to Union Special specification No. 175. Fill main reservoir at plug screw (B, Fig. 2) and check oil level at gauge (C); oil is at maximum level when needle is in yellow band marked "full". Oil should be added when needle is in yellow band marked "low".

It is recommended that a new machine, or one that has been out of service for an extended period, be lubricated as follows: Remove the end cover and directly oil the bearings of the needle bar link, take-up and its lever and needle bar. Replace end cover as no further hand oiling will be required.

CAUTION! The machine is provided with automatic or manual head mechanism oil control. The oil control dial (D, Fig. 2) is shown in the automatic oiling position, and should manual oiling of the head mechanism be desired, remove locking screw (G, Fig. 2) and turn dial 180° to expose the manual oiling port. In the manual oiling position, five or six drops of oil should be introduced into the oiling port twice daily - preferably at starting time and mid-day.

Oil may be drained from main reservoir by removing plug screw (F, Fig. 2).

OIL GAUGE

The oil gauge is set at the factory to show the proper oil level in the reservoir. Should an adjustment become necessary, the following steps should be followed:

1. Place the machine upright on a level table or bench.
2. Remove the reservoir plug screw (located below the handwheel and near the bottom of the machine).
3. Oil should be added or removed so that the oil level is approximately 1/8 inch below the bottom edge of the hole.
4. Loosen the lock nut on the calibrating screw, and turn the screw left or right so that the gauge needle rests on the yellow band marked "FULL" on gauge (C, Fig. 2).
5. Tighten lock nut and replace plug screw.

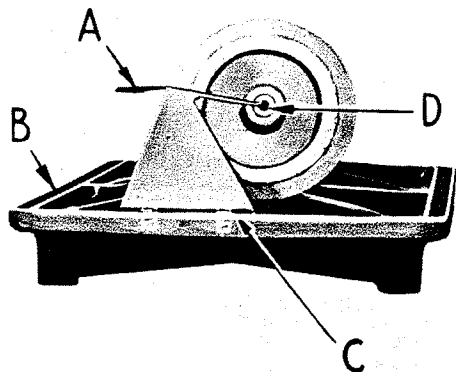

Fig. 3

Lubrication of the mechanism below the cloth plate is automatically accomplished through the feed driving shaft (D, Fig. 3), which is tubular. Oil is introduced into the shaft at the sprocket end by means of an oil distributing plate (A, Fig. 3) which is secured to the bottom cover (B) by means of two screws (C).

Should it become necessary to remove the reservoir cover, it is imperative that the adjustment of the oil distributing plate (A) be checked very carefully. This can be done by removing the large plug screw at the right end of the reservoir and looking through the hole. The low point of the oil distributing plate must be even with or slightly below the center of shaft (D) and just touching it.

SELF-PRIMING HEAD OIL SIPHON

Class 63400 machines are equipped with a self-priming head oil siphon. When the machine is started, oil splashes on the priming cup felt, filters through the felt and trickles down the vertical oil tube, thus priming the siphon. Once the prime is established, it is maintained, unless the felts are removed. The siphon operates twenty-four hours a day, removing oil that accumulates in the head, even when the machine is not running.

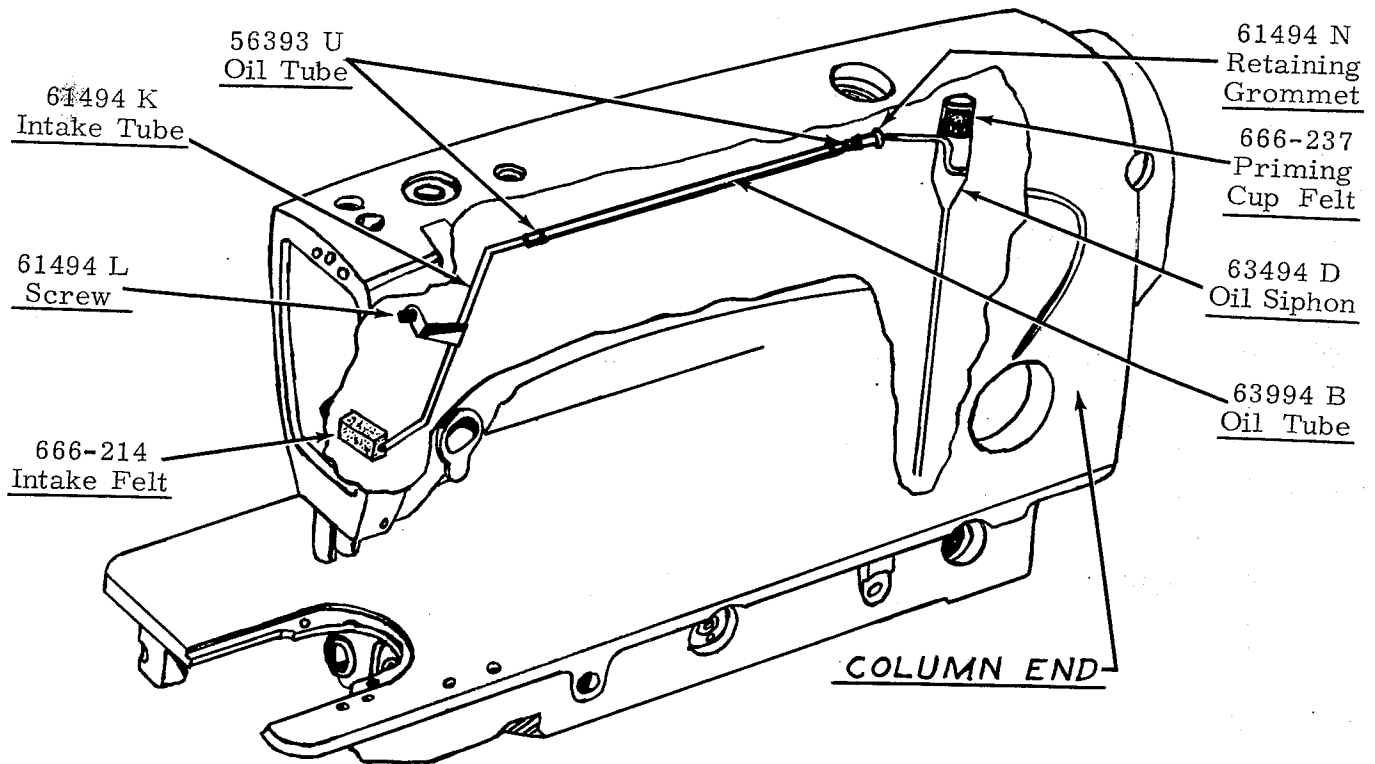

INSTALLING AND MAINTENANCE OF OIL SIPHON

The felt in the priming cup is designed for a specific purpose. This felt, No. 666-237 is thin and relatively dense to meter the flow of priming oil and to prevent the entrance of air. The felt, at the intake of the siphon, keeps the siphon clear of lint, and prevents the entrance of air at that point.

A newly installed siphon starts its action within five to ten minutes after the machine is operating. However, it may be forty minutes or so before the air is removed from the line and the siphon is in full operation.

When a customer receives a new machine, it has probably been turned upside down in shipping, oil has accumulated in the head, and the siphon may not be primed. It will, however, automatically reprime itself when run. After the first day of operation, the siphon can be checked by inspecting the tygon tube at the junction visible at the presser foot lifter arm to be sure it is full of oil.

The siphon may also be checked by removing the head cover and wetting the inlet felt with oil. The felt should visibly dry out as the oil is drawn into the siphon.

If the siphon felts become clogged and the siphon does not function properly, change the felts as follows:

To change the inlet felt, remove the inlet tube with the tygon tube disconnected only at the column end. Replace the felt and reassemble.

To change the prime cup felt, first remove the access plug screw at the rear of the column. Remove felt with a tweezers. Replace with a new felt being sure the felt is pushed down tightly into the prime cup.

INSTRUCTIONS FOR OPERATORS

THREAD

While the direction of the twist in the bobbinthread is immaterial, the direction of the hook rotation favors the use of a left twist thread in the needle. To determine the direction of twist, grasp a short length of thread between thumb and forefinger of each hand. Turn the thread away from you with your right hand. If the strands unwind, it is a left twist, if not, it is a right twist.

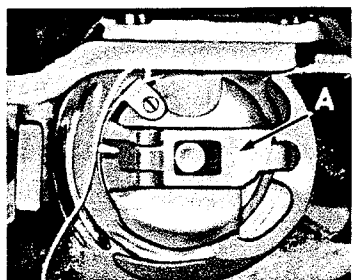

Fig. 4

REMOVING THE BOBBIN CASE

To remove the bobbin case, turn handwheel in operating direction until the needle reaches its highest position. Using the left hand, reach under the table, open the bobbin case latch (A, Fig. 4), and pull the bobbin case out of the sewing hook.

Opening the latch retains the bobbin in the case. When the latch is closed, the bobbin is released and can readily be removed.

WINDING THE BOBBIN

Thread the bobbin winder by leading the thread from the supply down through the eyelet (A, Fig. 5), down between the tension discs, and under the tension post. Press an empty bobbin on the winder shaft (B) up to the stop, wind the end of thread around the bobbin a few turns in a clockwise direction, and press downwardly on hand lever (D) until pulley is moved into contact with machine belt, and is locked in that position. When the machine is operated, the bobbin will be rotated and filled until the thread engages the automatic throw-out member, which disengages the pulley. The extent to which the bobbin is filled can be varied by regulating the screw (C).

The tension post bracket is mounted on the winder base, and can be shifted from left to right by loosening screw (E) so that any tendency of the bobbin to wind unevenly may be readily corrected.

The purpose of the bobbin winder is to assure an operator of a full bobbin at all times. When the bobbin in the machine is used up, replace it with the full one, and begin to wind the empty one immediately. Bobbins can be rewound while the machine is sewing.

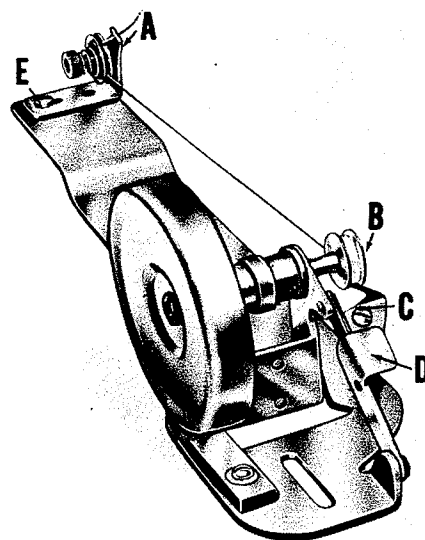

Fig. 5

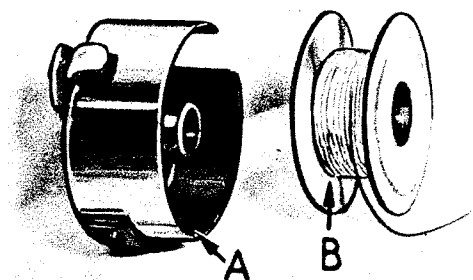

Fig. 6

THREADING THE BOBBIN CASE

The bobbin case should be held between the thumb, forefinger and second finger of the LEFT hand (A, Fig. 6).

The bobbin itself should be held between the thumb and forefinger of the right hand (B, Fig. 6) with thread coming off the bottom of the bobbin.

INSTRUCTIONS FOR OPERATORS (Continued)

THREADING THE BOBBIN CASE (Continued)

Place the bobbin in the bobbin case. In one continuous motion, with the thumb and forefinger of the right hand, draw the bobbin thread through the diagonal slot in bobbin case (A, Fig. 7) under the tension spring (B) and into self threading eyelet (C) on case. Note the direction of the rotation of the bobbin as the end of the thread is pulled when looking at the bobbin case from the back. The bobbin should rotate counterclockwise.

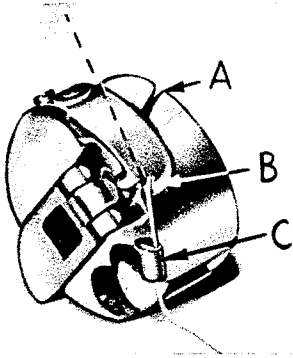

Fig. 7

REPLACING THE BOBBIN CASE

Have the needle bar at its highest position, allow about two and one half inches of thread to hang free. The bobbin case latch should be opened with the left hand, and by reaching under the table and through the opening in the table, it should be placed part way into the sewing hook. The latch should then be released and bobbin case snapped into position.

INSERTING THE NEEDLE

Insert the needle into the needle bar as far as it will go with the spot (sometimes called scarf) toward the right, facing the handwheel. Tighten set screw securely.

The cross hole in the needle bar, about 1/4 inch from the end (A, Fig. 8), is to show the operator when the needle has been inserted as far up as it will go, and to provide a means for cleaning the accumulated lint from needle hole so the needle will seat properly.

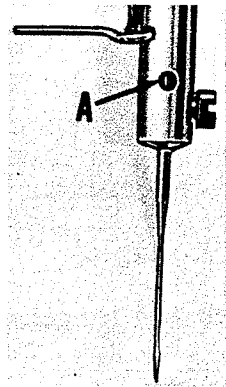

Fig. 8

THREADING THE NEEDLE

Threading diagram (Fig. 2) shows the places where the needle thread passes. Please note that the needle thread passes through the needle eye from left to right.

PREPARATION FOR SEWING

With your left hand, hold the end of the needle thread, leaving it slack, and turn the handwheel in operating direction until the needle moves down and up again to its highest position. Pull up the needle thread and the bobbin thread will come up with it through the needle hole in the throat plate. Draw both threads under the presser foot.

TENSIONS

A perfect stitch is one in which the needle thread and bobbin thread are locked together in the center of the material being sewed. A stitch of this kind is secured by regulating the tensions on both threads.

BOBBIN THREAD TENSION

The tension on the bobbin case is applied by means of a set screw (A, Fig. 9) which regulates tension spring (B). The tension on the spring is correct when it is just sufficient to hold the bobbin case and bobbin suspended by the bobbin thread. The thread should not be in the eyelet for this adjustment check.

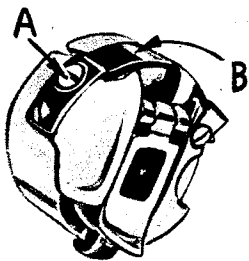

Fig. 9

INSTRUCTIONS FOR OPERATORS (Continued)

BOBBIN THREAD TENSION (Continued)

Remove the bobbin case from its holder and turn set screw in spring in a clockwise direction to apply more tension or counterclockwise to release tension.

When the bobbin thread tension is correct, it rarely becomes necessary to make any changes as varying the needle thread tension will usually attain a good stitch.

NEEDLE THREAD TENSION

The needle thread tension is varied by turning the tension regulating nut (H, Fig. 2). Turning the nut in a clockwise direction increases the tension, while counterclockwise decreases it. This should not be done when the presser foot is in its raised position, but is generally done while the machine is sewing on a piece of scrap material.

TO CHANGE THE STITCH LENGTH

Press plunger (J, Fig. 2) in firmly. While holding plunger in, turn handwheel in operating direction until stitch regulating finger is felt to drop into the slot of feed eccentric. Continuing to hold the plunger in, turn handwheel in operating direction to increase the stitch length and in opposite direction to decrease the stitch length.

Stitch lengths are indicated by graduations on the indicator dial and are viewed through the window in the belt guard (K, Fig. 2).

PRESSURE ON MATERIAL

The presser spring should exert only enough pressure to make the work feed uniformly. To increase the pressure on the presser foot, turn presser spring regulator (A, Fig. 10) in clockwise direction. Turning the regulator counterclockwise decreases the pressure.

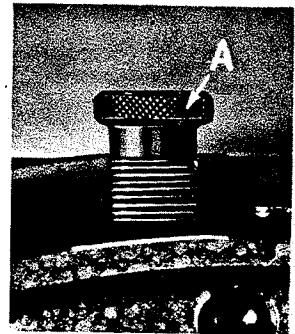

Fig. 10

INSTRUCTIONS FOR MECHANICS

SETTING THE NEEDLE BAR TO HEIGHT

The lower needle bar bushing, the one to which the needle bar is timed, is set at the factory. The distance from the bottom of bushing (A, Fig. 11) to the throat plate seat is $2\frac{1}{4}$ inches.

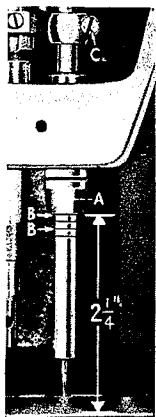

Fig. 11

The four lines engraved on the needle bar are used in setting needle bar to height and are referred to as TIMING LINES. The two upper lines are used with the extra short length needle Type 183 GXs or 183 GYS, which are recommended for Style 63400 A.

The two lower lines are used with the short length needle Type 180 GXs or 180 GYS, which are recommended for Style 63400 B.

When the needle bar is at its lowest position, the upper timing line (B, Fig. 11) (of the pair selected) dependent upon the needle used, should be EVEN with the lower edge of the lower needle bar bushing (A).

To change the position of the needle bar, turn the handwheel until the bar is at its lowest position. Then, loosen the clamp screw (C) and move the bar to the proper timing line. Keeping the needle bar link at its lowest position, tighten screw securely.

The illustration (Fig. 11) shows the proper setting of the needle bar on Style 63400 A, using extra short length needle, Type 183 GXs or 183 GYS. The setting of the needle bar on Style 63400 B, using short length needle, Type 180 GXs or 180 GYS, is accomplished in the same manner, except that the lower pair of timing marks on the bar is used.

TIMING THE HOOK

Tip the machine back so that it rests on the rest pin in the table top. Insert a new needle. Loosen the two screws and swing out the bobbin case positioning finger (A, Fig. 12). Loosen the three set screws (B) in the hook and hold the hook and bobbin case holder in such a position as to prevent interference with the needle. Turn the handwheel in operating direction until the needle bar is at its lowest position and continue to turn the handwheel until the needle is ascending and the lower timing mark (of the pair selected) (Fig. 11) used in setting the needle bar is even with the lower edge of the needle bar bushing (A).

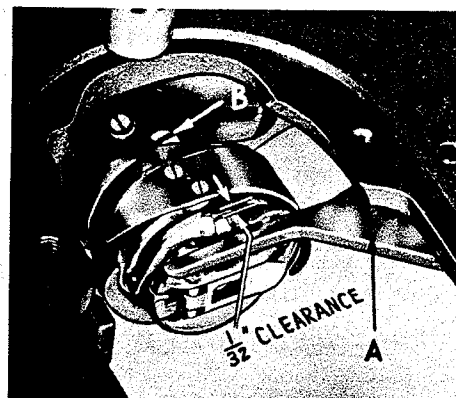

Fig. 12

Turn the hook on the shaft until the point of the hook is even with the center of the needle and as close to the needle as possible without deflecting it. A spacing of .003 to .005 inch between the needle and the point of the hook is satisfactory. With the hook in this position, tighten the set screw opposite the hook point securely. Then, tighten the two remaining screws securely and recheck the timing of the hook with the needle, at which time, the top of the eye of the needle should be about $\frac{1}{64}$ inch below the bottom of the hook point. If this condition does not exist, recheck the setting of the needle bar bushing in relation to the throat plate seat (Fig. 11).

Adjust the bobbin case holder positioning finger by turning the bobbin case holder until the finger recess is at the top. Place the projection on the finger into the bobbin case holder recess and tighten the finger attaching screws securely, allowing $\frac{1}{32}$ inch clearance between the outside edge of projection and the inside edge of bobbin case recess (Fig. 12).

INSTRUCTIONS FOR MECHANICS (Continued)

NEEDLE GUARD INSTRUCTIONS FOR NO. 29474 P

In the hook, at the right side of the needle hole in the bobbin case holder (B, Fig. 13) is found a needle guarding surface (A, Fig. 13).

The purpose of this guarding surface is to prevent the hook point (C) from coming in contact with the needle (D) at loop-taking time, should the needle be deflected toward the hook point. The needle guard will deflect the needle slightly, when needle is at bottom of its vertical travel, if the hook is properly timed. (At loop-taking time, there should be little or no deflection of needle by the needle guard.)

For additional needle clearance, especially with use of size .048 and larger needles, removal of some needle guarding surface may be necessary.

Before metal removal from the guarding surface, all related settings should be checked as follows:

1. See that the needle bar is set to correct height.
2. Check for proper hook timing.
3. Rotate handwheel in operating direction by hand. Check for excessive needle deflection beyond what is cited above as a desirable condition.
4. If needle deflection is excessive, follow steps 1 and 2 below.
 - (1) Remove bobbin case holder from hook.
 - (2) Remove excess metal from needle guarding surface. This may be done by using a 1/8 inch strip of fine emery cloth (#320), with one end secured to the bench and rubbing the guarding surface back and forth until sufficient metal is removed. When metal is being removed from needle guarding surface, the bobbin case holder should be re-inserted frequently and tested until proper needle guarding is obtained.

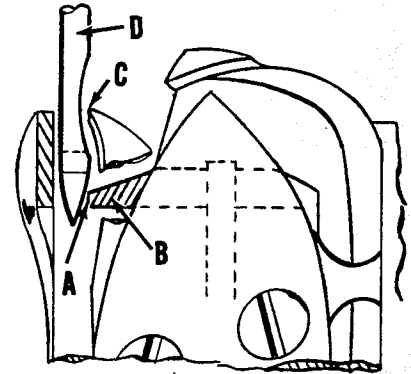

Fig. 13

CAUTION! Damage to hook point may result if too much metal is removed from needle guarding surface.

The bobbin case holder should be thoroughly cleaned before re-assembly into hook base.

When altering needle guarding surface, it is suggested the hook NOT BE REMOVED or disturbed from its timed position.

Bobbin case holder only may be removed by removing gib screws and gib and by pulling on bobbin case stem as the handwheel is rocked backwards and forwards slightly.

HOOK LUBRICATION

CAUTION! Do not run the machine without the bobbin case in the hook as hook damage may result.

With the bobbin case in the hook, run the machine for a full minute. Place a piece of white paper directly under the hook and continue running the machine. After about five seconds, remove the paper and a definite and distinct pattern of oil spots should be observed.

HOOK LUBRICATION (Continued)

Should more or less oil be required, turn the oil control adjusting shaft (E, Fig. 2), located on the front of the machine just below the cloth plate surface, in the direction of the change required. After a change in the hook oil flow, the machine should be run about one minute before checking for the desired oil flow.

FEED DOG HEIGHT

In regulating the height of the feed dog, it should be at its highest position and the presser foot resting directly against it.

The feed dog holder attaching screw (A, Fig. 14) should be loosened slightly, and regulating screw (B)

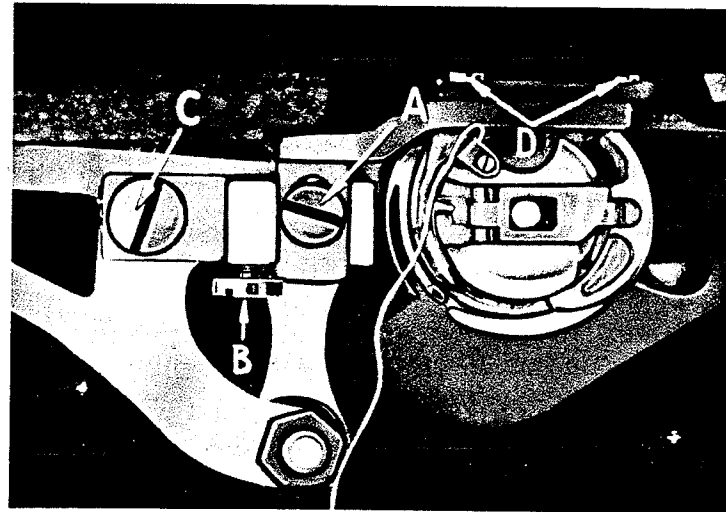

Fig. 14

should be turned either clockwise, to raise the feed dog, or counterclockwise to lower it. Make sure that the bottom of the shank of the feed dog holder rests against the head of the regulating screw.

A suggested initial setting is as follows: Feed dogs having 22 or more teeth per inch should show about 3/64 inch above the throat plate at highest point of travel. Those having 16 or less teeth per inch should show the depth of a full tooth above the throat plate.

The feed dog can be tilted up or down as required by loosening screws (A and C).

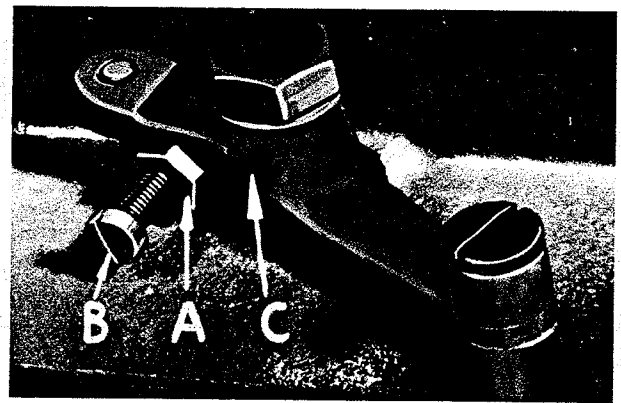

Fig. 15

Loosen feed dog holding screws (D) to space the feed dog, front to back or sideways in the throat plate.

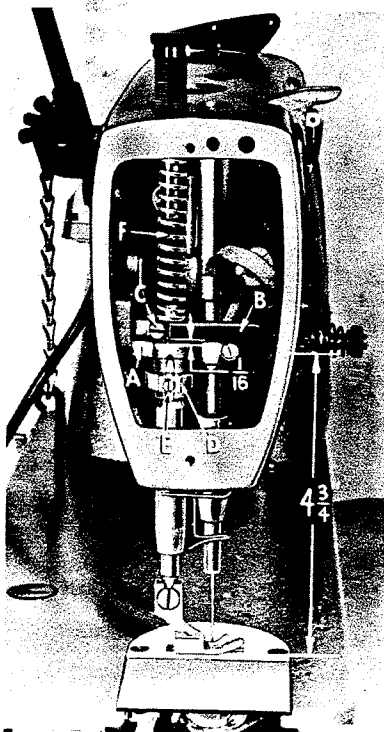

Fig. 16

PRESSER BAR CONNECTION

The presser bar connection (A, Fig. 16) should be set so that it is about 1/16 inch below the presser bar guide (B). This is accomplished by tipping the machine back against the rest pin, loosening the lock nut (A, Fig. 15), and relocating the stop screw (B) on the lifter lever bell crank (C). By turning the stop screw to the right or left, the proper setting of the presser bar connection is accomplished. Tighten the lock nut (A) to lock the stop screw in place.

INSTRUCTIONS FOR MECHANICS (Continued)

PRESSER BAR GUIDE

When locating the presser bar guide (B, Fig. 16), the presser foot must rest directly against the throat plate with the feed dog in its lowest position. The guide is set properly when there is a 4 3/4 inch space between the thread take-up wire and the top of the throat plate (Fig. 16)

To obtain this setting, remove the pressure from the presser spring (F) and loosen set screw (C). Tap on presser foot to insure its being down on the throat plate. Set the guide to the 4 3/4 inch dimension, center the foot by turning it so that the needle enters the middle of its slot and retighten screw (C) in guide. Now, apply pressure to the presser foot by turning the regulator (A, Fig. 10) clockwise.

PRESSER BAR

The presser bar No. 63457 J is designed primarily to receive Union Special presser feet. However, should feet of a different manufacture be required, the presser bar is adaptable.

To adapt the machine to receive presser feet of other manufacture, proceed as follows:

1. Remove presser foot and presser foot screw from presser bar.
2. Insert Presser foot screw in the presser bar so it screws in from right to left.
3. Loosen the set screw in the presser bar guide and rotate presser bar 180° using the screw as a handle.
4. Attach presser foot to the bar and align the needle hole or slot of the foot with the needle.
5. Check the presser bar guide for correct height and tighten set screw securely.

CAUTION! When presser feet other than of Union Special manufacture are used, the presser guide height must be checked and reset where necessary.

TENSION ASSEMBLY ADJUSTMENT

Test check spring tension (A, Fig. 17). There should be enough tension to assure a good returning snap when spring is depressed and released. Should it require adjusting, loosen set screw in the head located under arm and to the right of tension assembly, and remove tension assembly. Partially loosen tension post set screw (B) in tension post socket (C). Turn the tension post (D) counterclockwise until the check spring moves away from the upper stop (E) and has no tension on it. Turn the tension post (D) in a clockwise direction until the spring again touches the upper stop (E). Then, proceed further in the same direction until the desired tension is obtained. When correctly set, the tension post set screw (B) should be drawn up snugly, yet not forcefully. Further adjustment of the check spring tension can be made by inserting a screwdriver into the slotted end of the tension post (D) and turning in the required direction.

Replace tension assembly with the check spring about 3/8 inch above the thread take-up wire. While the tension post assembly is being replaced, the presser foot should be resting on the throat plate.

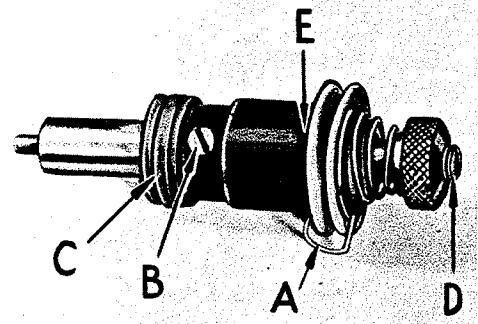

Fig. 17

INSTRUCTIONS FOR MECHANICS (Continued)

TENSION RELEASE

The tension release should be set so that it will not release when sewing over seams or when the presser foot is raised for back tacking. The adjustment of the tension release cam (D, Fig. 16) and the in and out position of the tension assembly are required for proper operation.

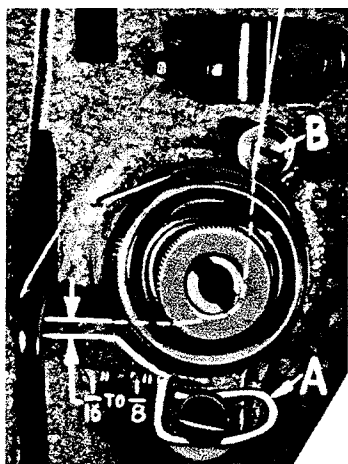

Fig. 18

insure a good returning snap when spring (B, Fig. 18A) is depressed and released. The check spring tension is adjusted from about 1 to 1 1/4 ounces when measured with a postal scale (C, Fig. 18A). This is measured when the check spring is 1/32 to 1/16 inch from its stop. The tension post set screw should be drawn up snugly but not forcefully tightened (B, Fig. 17). The tension release pin should move freely in the tension post (D, Fig. 17). The check spring eyelet (A, Fig. 18), located just below the tension discs, should be set for correct height as follows:

With a thread running from the tension post to the thread wire in a straight line, the check spring eyelet should be set 1/16 to 1/8 inch below the thread line (Fig. 18). Be sure the eyelet is set close to the tension discs so that the check spring will pass freely over it without obstruction. After making this setting, proceed to thread machine as per threading diagram (Fig. 2).

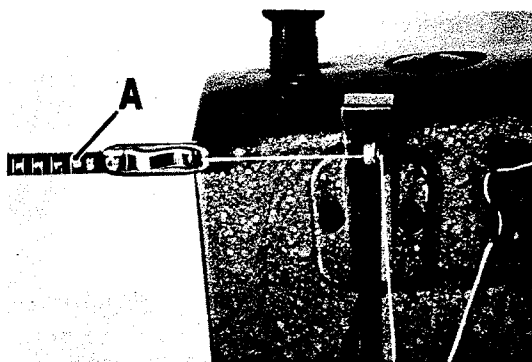

Fig. 18B

The in and out position of the tension assembly is correct when the tension discs are in line with the check spring eyelet (A, Fig. 18). Set the stop screw (B, Fig. 18) so that when the flange of the tension assembly rests against it, this position is maintained. Tighten the tension assembly set screw.

The tension release cam (D, Fig. 16) should now be positioned by loosening set screw (E, Fig. 16) and then raising or lowering the cam to suit the sewing conditions, the average release point being between 1/4 to 5/16 inch of presser foot lift above the throat plate. Tighten tension release cam set screw securely.

THREAD CONTROL

Check the adjustment of tension assembly (A, Fig. 18A). Check spring tension. There should be enough tension to

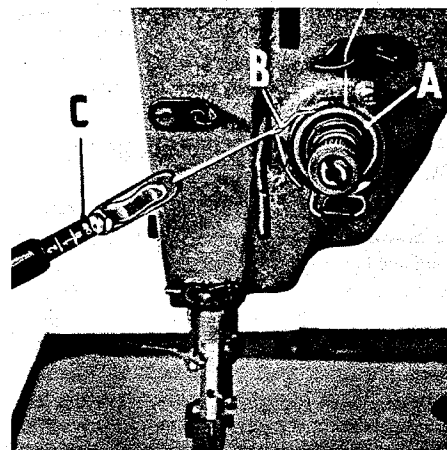

Fig. 18A

Sew slowly on a piece of material and observe the action of the check spring. The thread from the check spring to the take-up wire should be taut when the take-up is at the bottom of its stroke. Slight changes in needle thread tension may be necessary at this point, but a reasonable tension should be used to maintain a uniform and consistent stitch. The machines are sewn off with 3 to 4 ounces needle thread tension on 70-2 cord or similar thread using a postal scale (A, Fig. 18B). Depress check spring when checking the tension. The check spring will feel heavy to you when compared to Class 61400 adjustment, but this is a required setting for the Class 63400, and as a result, the disc tension can be reduced.

BOTTOM COVER

Before removing the bottom cover, place the machine on bench so that the plug screw is accessible from underneath. Remove this plug screw and catch the reservoir oil in some convenient clean container. Tip the machine back, loosen and remove the two cover screws. The cover should be tapped free with a wooden block or mallet. Do not pry cover loose with any sharp instrument as the gasket may become damaged.

CAUTION! When the bottom cover is removed, care should be taken not to mar or scratch the gasket seat area of the machine bottom.

Before replacing the cover, the machine gasket seat should be wiped clean and free of all lint and dirt. The cover gasket should also be inspected for damage and cleaned of dirt. Two additional gaskets are used to seal the bolts and must be cleaned before assembly. Carefully set the cover in place and tighten the two bolts securely.

To replace a damaged cover gasket, proceed as follows:

1. Clean cover gasket recess of any foreign matter.
2. The gasket in cross section is triangular in shape with a groove in the top or widest part. With the cover resting as it does in the machine, oil distributing plate to your right, begin inserting the gasket in the middle of the back recess. The grooved wide edge of the gasket should be up and the long sloped edge inward. Continue pressing the gasket into the cover recess until gasket is in place.

The bolt sealing gaskets may have a tendency to fall out when installing the cover, but may be temporarily cemented in place by applying grease to their recesses.

HOOK SHAFT

The hook shaft (A, Fig. 19) is held in position by the pinion (B) and collar (C) thrusting against hard steel washers (D) between the long left hand bushing (E) and the short right hand bushing (F).

Should the hook shaft setting be disturbed, the left and right position can be determined by measuring from the hook end of the hook shaft to the point of a new needle (G) and reading $35/64$ inch on a scale.

To reposition the hook shaft, loosen the set screws of the pinion and collar and establish the $35/64$ inch dimension. Move the pinion and thrust washer against the left bushing, and after making certain one of the set screws is on the shaft FLAT, tighten both screws securely. Liberally coat the collar and its washer with oil and press the collar away from the pinion so as to remove all end play and tighten both set screws securely.

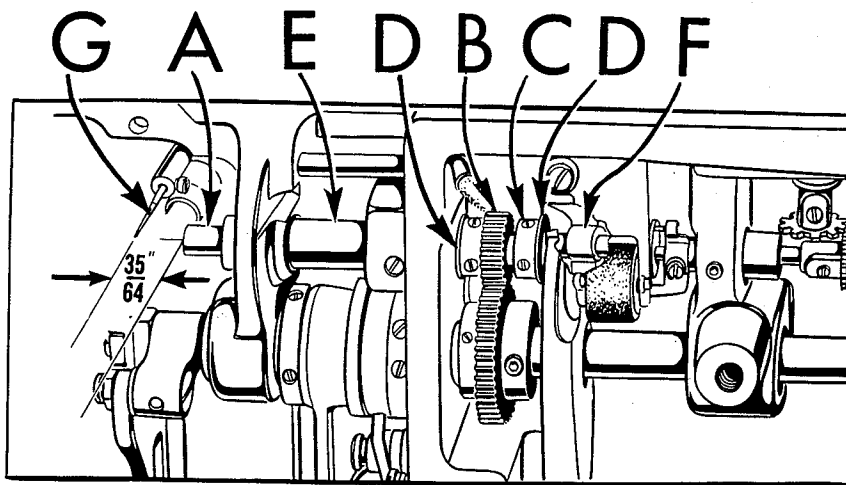

Fig. 19

Hook oiling is accomplished by a high speed rotary pump on the end of the hook shaft. The quantity of oil supplied to the hook is regulated by the longer or shorter path the oil is required to travel through the metering felt of metering cup (G, Fig. 20). (Increase or decrease of oil supply is controlled by a dial (P, Fig. 20) with an arrow marked "INCREASE", found below the cloth plate). The hook oil feed roller (A, Fig. 20) which rests against the metering cup felt serves not only to feed oil to the unit from the oil reservoir, but filters the oil as well.

REMOVAL OF OILING DEVICE

The following steps are necessary to remove hook oiling device:

1. Remove hook oil feed roller (A, Fig. 20).
2. Remove hook oil control finger (B).
3. Apply finger pressure to hook oil control shaft (D) to prevent loss of pump disc pivot pin (E); using Allen wrench, loosen set screw (C). Move assembly slowly to right, being careful not to drop pivot pin located in the end of the hook oil control shaft. When pivot pin is clear of pump disc (F), disc is free to fall.
4. Remove metering cup (G) along with oil supply felt (K) and air seal felt (J).
5. Remove cog (H) from hook oil control shaft.

INSTRUCTIONS FOR MECHANICS (Continued)

RE-ASSEMBLY OF OILING DEVICE

Before re-assembly, the end of the hook shaft, its spiral groove and the pump disc should be thoroughly cleaned. Remove any end play found in hook shaft and determine that the $35/64$ inch dimension has been maintained (Fig. 19).

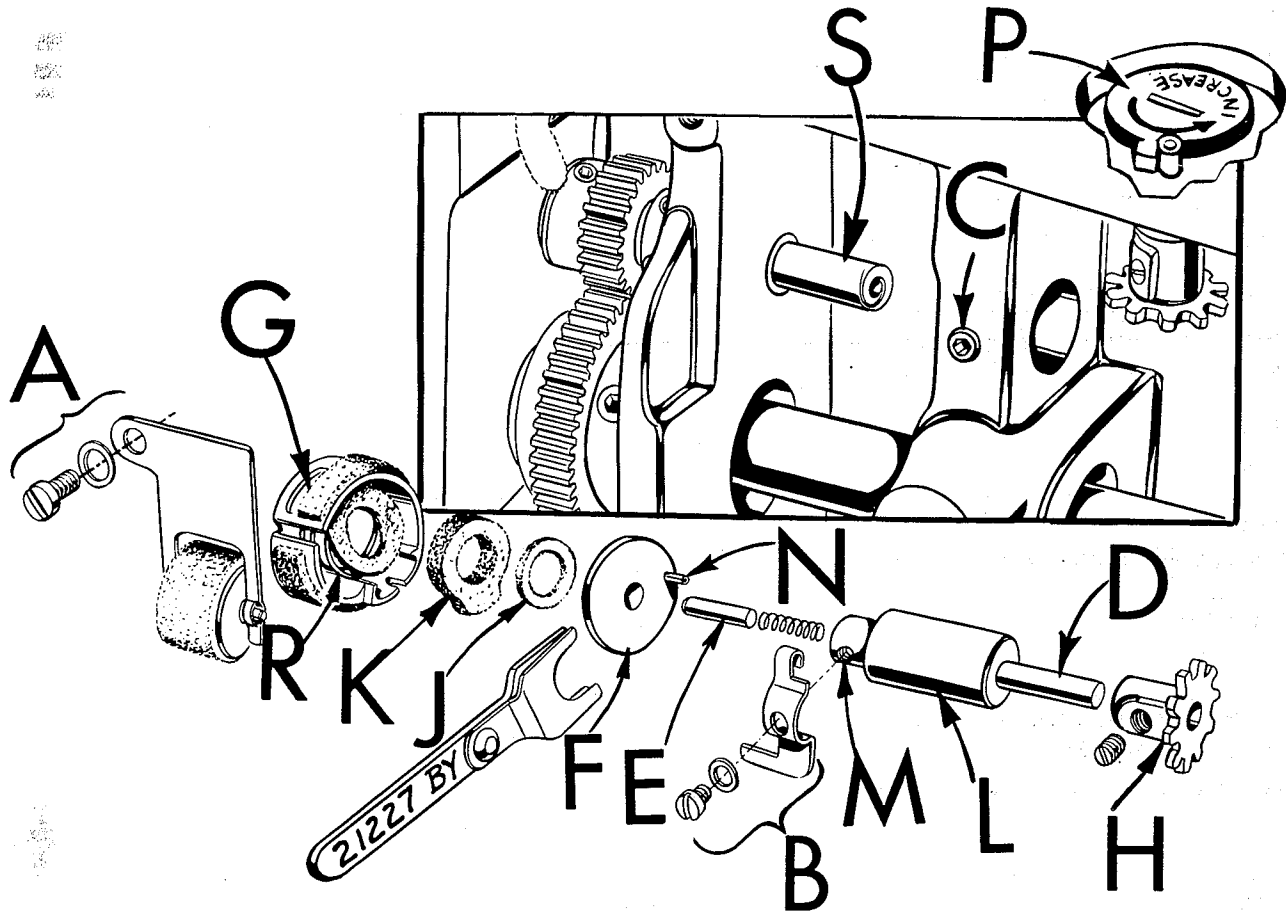

Fig. 20

The following steps are necessary to re-assemble the hook oiling device:

1. Remove and separate the air seal felt (J, Fig. 20) from oil supply felt (K).
2. Make sure small end of air seal spring (R) is located on boss of metering cup behind felt attached to cup. Position metering cup (G) and air seal spring on hook shaft (S) with open end toward handwheel end of machine (Fig. 20).

NOTE: The hook shaft should pass through hole of felt attached to metering cup.

3. Position oil supply felt (K, Fig. 21) on hook shaft making certain the felt's projection extends into dovetail of metering cup.
4. Position air seal felt (J) on hook shaft.
5. Insert pump disc (F) into assembly tool No. 21227 BY, with stop pin on the spring side of tool, 180° from handle. Insert disc approximately half way into spring and center in tool (Fig. 22).

INSTRUCTIONS FOR MECHANICS (Continued)

RE-ASSEMBLY OF OILING DEVICE (Continued)

6. Insert hook oil control shaft (D) and its bushing (L) part way into its boss which is located directly behind the hook shaft, being careful NOT TO DROP the pump disc pivot pin (E).

7. A clearance cut on the edge of the metering cup, located between the dovetail and the long horizontal slot, has been provided for the pump disc tool and should be facing you (Fig. 22).

8. With the fork of the tool in line with the metering cup clearance cut and centered about the hook shaft end, press the felts to the left with the tool until the pump disc is in contact with the end of the hook shaft.

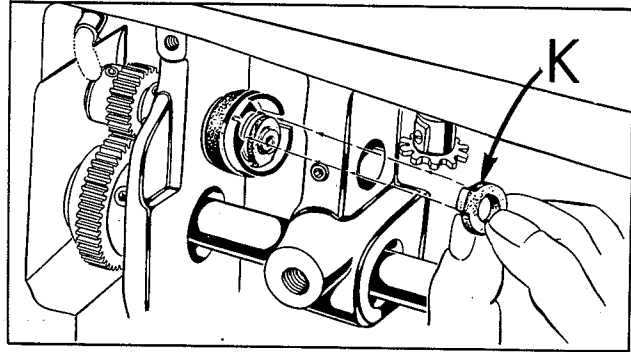

Fig. 21

9. Press hook oil control shaft bushing (L) to left until control shaft (D) is approximately 1/16 inch away from pump disc (F). Make sure the control shaft pivot pin (E) seats in the depression at the center of the pump disc. Tighten set screw (C, Fig. 22) and withdraw assembly tool. Be sure air seal felt (J) has seated against the pump disc.

10. Turn hook oil control shaft (D, Fig. 23) until screw hole (M) is accessible. Manually rotate pump disc (F) so its stop pin (N) is 90° above screw hole.

11. Rotate metering cup so the short slot (T) is 180° from the stop pin (N). Now, install the hook oil control finger (B) by first hanging the hooked portion of the finger over the stop pin (N) and lowering to insert the projection at bottom left into the short slot of the metering cup. Tighten finger (B) in place by means of screw and washer, making sure the hook oil control finger does not bind or distort the metering cup.

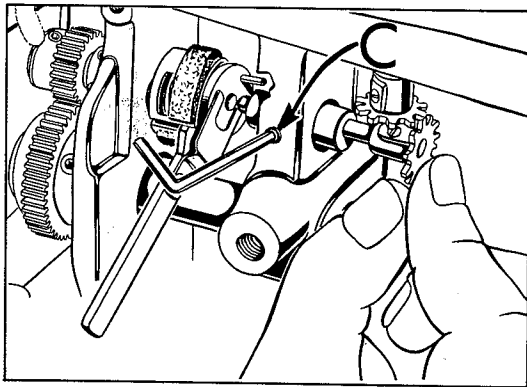

Fig. 22

12. Assemble the hook oil feed roller (A, Fig. 24), and rotate the metering cup so that the roller contacts the metering cup felt at point (U, Fig. 24). Turn the oil control adjusting shaft (P, Fig. 24) in the increase direction until projection stops against the stop pin (this is maximum oil supply) and install the cog (H, Fig. 24) on the hook oil control shaft. After meshing the teeth, tighten the set screw securely.

13. Check for proper contact of the hook oil feed roller and the metering cup by turning the oil control adjusting shaft through its complete travel and observe the feed roller turning as the metering cup turns. With the oil control adjusting shaft set at maximum, the feed roller point of contact with the metering cup felt should be at the mid-point of the slot that permits the metering cup felt to enter the metering cup.

NOTE: The feed roller should be in contact with the metering cup felt through its complete travel.

INSTRUCTIONS FOR MECHANICS (Continued)

UPPER MAIN SHAFT

In a high speed machine, the alignment of the take-up mechanism is extremely important and is controlled by the left and right position of the upper main shaft. Should the main shaft position be altered, it is imperative that the take-up alignment be checked before operating.

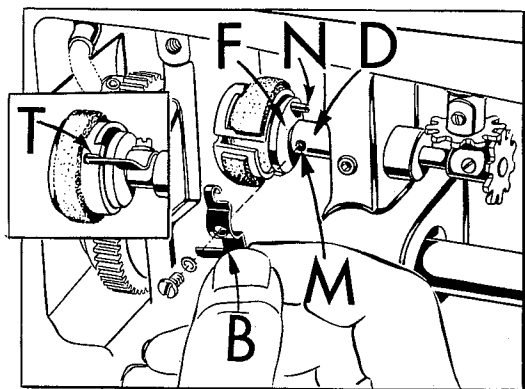

Fig. 23

for operation of the take-up in the center of the lateral play. Now, line up the take-up lever hole with the hole in the lever boss. Insert the oil wick about 1/2 inch in the bore of the take-up lever. With the oil wick groove up, insert the take-up lever pin in the lever, making sure the wick is in the groove and press the pin into its hole in the arm. There should be no end play in the take-up lever after the set screw is securely tightened.

Should the alignment test show the main shaft is out of position, the upper sprocket and handwheel should be loosened and the shaft moved left or right as the conditions indicate. Re-tighten sprocket and handwheel so that there is no end play in the upper main shaft and repeat the alignment check.

HANDWHEEL

The handwheel is constructed so as to minimize noise and is therefore isolated from the pulley by shock mounts. If for any reason the handwheel is disassembled, the following steps should be used for re-assembly.

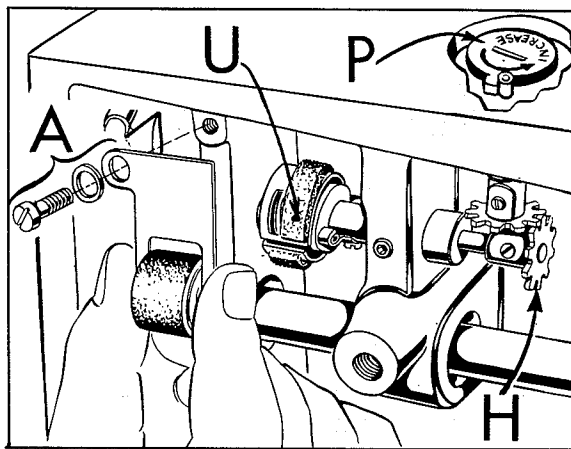

Fig. 24

1. Using the upper main shaft as a mandrel, assemble the pulley thrust face down so that at least 1 1/2 inches of the shaft protrudes above it. Tighten the two set screws.
2. Place the rubber isolator ring on the pulley face and align holes.
3. Carefully slide handwheel down the shaft to contact the isolator and align the three holes.

TO CHECK FOR ALIGNMENT

1. Remove the presser bar spring and regulator screw.
2. Rotate the handwheel so that the needle bar is at the bottom of its stroke.
3. Remove the take-up lever pin.
4. With light inward finger pressure, move the take-up lever to the take-up lever boss. There should be a small amount of interference between the lever and the boss. With light outward finger pressure, move the lever across the boss face. There should be clearance between the boss face and lever. These two tests in effect are checking the lateral play of the take-up lever and provides

INSTRUCTIONS FOR MECHANICS (Continued)

HANDWHEEL (Continued)

4. Three plastic "O" rings are now inserted into their respective holes in the handwheel.
5. The outer isolator ring and cap are now assembled.
6. Insert the three screws that are run through the complete assembly and tightened lightly.
7. Loosen the two pulley screws and slowly revolve the whole assembly several times for good alignment. Now, gradually tighten the three screws moving from one to the other until all are snug.
8. The assembly should run true as it revolves freely on the shaft. If any sidewise run-out is noted, it can be corrected by slight changes of screw pressure in the three isolator screws.

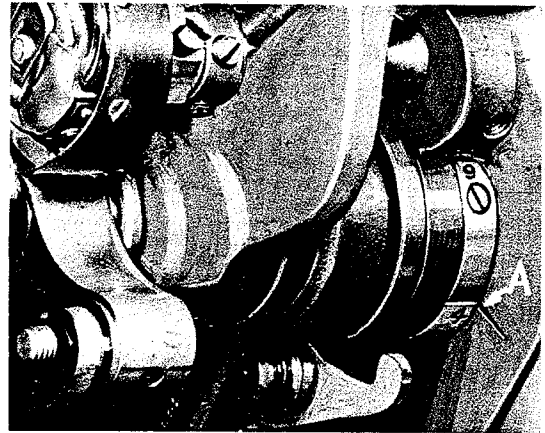

Fig. 25

CAUTION! When replacing the handwheel assembly on the mainshaft, care must be taken not to damage the oil seal located near the end of the shaft. The surface of the ring should be lightly oiled and the handwheel worked over the seal gently. Upper main shaft should be held securely to the right when sliding handwheel over seal to prevent damage to the take-up mechanism.

STITCH LENGTH INDICATOR

After a feed timing change, the stitch length indicator will have to be re-adjusted to read accurately.

1. Depress the stitch length change button until it engages in the feed eccentric.
2. Turn the handwheel toward you until the stop is reached, indicating the longest stitch length.
3. Loosen the stitch length indicator set screws.
4. With the change button still engaged, set the indicator dial to read "L" in the window on the belt guard.
5. Tighten indicator dial set screws.

TIMING THE MACHINE

Tip the machine back against the rest pin and turn handwheel until the needle bar is at the top of its stroke. The timing line "4" on the feed drive eccentric should line up with the mark on the wall of the casting (A, Fig. 25).

INSTRUCTIONS FOR MECHANICS (Continued)

TO SET THE FEED TIMING

1. Remove the needle from the needle bar.
2. Remove large plug screws below the oil gauge and below the handwheel.
3. Turn the handwheel until the needle bar is at the top of its stroke.
4. Loosen the lower sprocket screws through the hole below the oil gauge.
5. Hold the handwheel securely and turn the lower main shaft until the timing line "4" on the adjustable feed driving eccentric and mark on the casting wall line up (A, Fig. 25).
6. Press the lower main shaft firmly toward the handwheel and with a screwdriver, press the lower sprocket toward the head of the machine. Through the access hole, retighten the two sprocket screws securely. There should be no end play in the lower main shaft.
7. A small quantity of lead seal should be applied on the threads of both plug screws before they are replaced.

CAUTION! After any feed timing change, the hook must be retimed.

LOWER MAIN SHAFT

Should the lower main shaft position be altered, it is important that the collar (61432 J), located between the hook driving gear and the left lower main shaft bushing, be located .020 inch from the bushing.

The belt should be assembled on the lower sprocket so that the second set screw is accessible through the large plug screw.

HEAD MECHANISM LUBRICATION ADJUSTMENT

The needle bar link (A, Figs. 26, 27) is lubricated at two points.

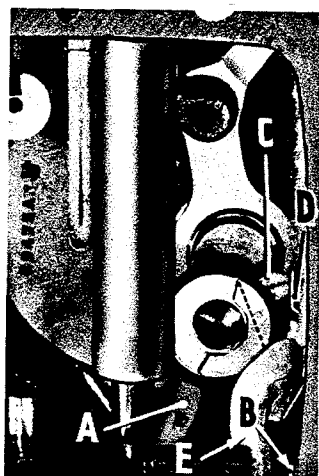

Fig. 27

1. Thrust washer (B, Fig. 26) must be positioned so that oil wick (C) wipes across the thin portion of the thrust washer. Washer is positioned by loosening left hand screw (D).
2. Position bracket by means of screw (B, Fig. 27) so that wick (C) passes through the center of the slot in needle bar link (A). Wick (C) must contact the needle bearings. Proper wick contact with the needle bearings can be obtained by bending the wick support bracket (D) closer or farther away from the needle bar link as required. Be sure to secure the felt strip (E) to the upper needle bar bushing with spring clip 61454 B.

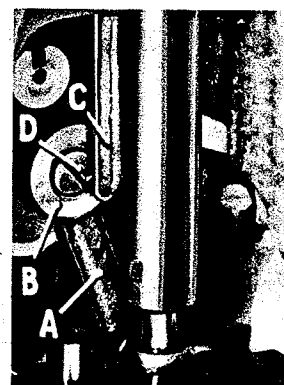
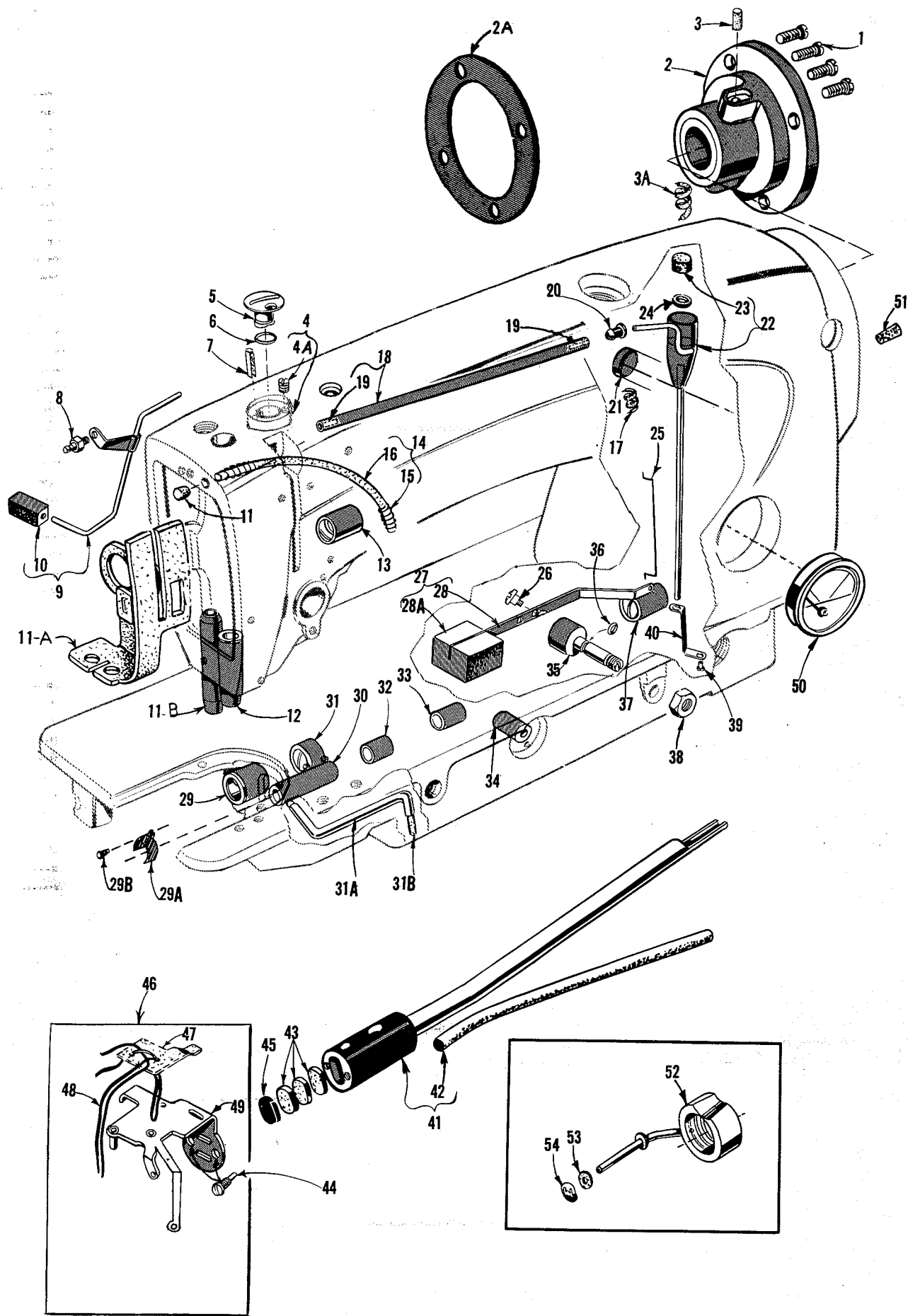

Fig. 26



MAIN FRAME, BUSHINGS AND HEAD OIL SIPHON

Ref. No.	Part No.	Description	Amt. Req.
1	22569 B	Screw -----	4
2	61490 B	Main Shaft Bearing Housing-----	1
2A	63490 B	Gasket -----	1
3	666-200	Oil Felt -----	1
3A	666-221	Oil Wick-----	1
4	50-982 Blk.	Head Oil Bushing, not used on new machines -----	1
4A	79077	Screw, not used on new machines -----	1
5	61493 C	Head Flow Oil Control Stud, not used on new machines-----	1
6	660-254	Oil Retainer Ring, not used on new machines -----	1
7	666-198	Oil Wick, not used on new machines -----	1
8	61494 L	Stud -----	1
9	61494 K	Oil Siphon Head Tube-----	1
10	666-214	Oil Felt -----	1
11	CO67 B	Plug-----	1
11A	666-231	Felt-----	1
11B	61457 K	Presser Bar Bushing-----	1
12	61454 C	Needle Bar Bushing, lower -----	1
13	61490 D	Upper Main Shaft Bushing, left -----	1
14	61471 F	Take-up Lever Hood Oil Diverting Wick and Spring -----	1
15	61471 D	Spring -----	1
16	666-194	Roll Felt -----	1
17	666-238	Bed Oil Drain Hole Felt -----	1
18	63494 N	Oil Siphon Connecting Tube -----	1
19	56393 AA	Oil Tube -----	2
*20	61494 N	Retaining Grommet -----	1
21	61293 N	Bed Plug -----	1
*22	63494 D	Head Oil Siphon Assembly -----	1
23	666-237	Felt Disc -----	1
24	6042 A	Washer, (use only on siphon with c'sunk bottom) -----	1
25	61494 H	Oil Gauge Connecting Link-----	1
26	21629 A	Screw -----	1
27	63494 C	Oil Gauge Float Assembly -----	1
28	61494 E	Oil Gauge Float Lever -----	1
28A	61494 D	Oil Gauge Float -----	1
29	61432 C	Feed Driving Shaft Bushing, left -----	1
29A	63432 E	Oil Shield -----	1
29B	18-768	Drive Screw -----	1
30	61441	Hook Shaft Bushing, left -----	1
31	61432 E	Feed Driving Shaft Oil Retaining Bushing, left -----	1
31A	63493	Hook Shaft Bushing Oil Tube -----	1
31B	666-212	Oil Felt -----	1
32	61441 A	Hook Shaft Bushing, right -----	1
33	61496 P	Hook Oil Control Shaft Bushing -----	1
34	61496 S	Hook Oiling Control Adjusting Bushing -----	1
35	61494 F	Float Lever Pivot Stud -----	1
36	660-221	"O" Ring -----	1
37	61432 B	Feed Driving Shaft Bushing, right -----	1
38	11635 B	Nut -----	1
*39	22564	Screw -----	1
*40	63494	Siphon Primer Position Bracket -----	1
41	61493 A	Head Oil Supply Line -----	1
42	666-109	Oil Wick -----	1
43	666-261	Felt Pad, for No. 61493 A -----	3
44	22784 K	Screw, for No. 63493 H -----	2
45	666-262	Felt, for No. 61493 A -----	1
46	63493 H	Head Oiler Assembly-----	1
47	666-191	Oil Distributing Felt -----	1
48		Oil Wick, 15 inches long-----	1
49	27-534 Blk.	Oil Shut-off Bracket -----	1
50	63494 K	Oil Gauge -----	1
51	CO67 B	Cork Plug-----	1
52	63493 J	Oil Siphon Assembly -----	1
53	666-273	Felt Disc -----	1
54	660-456	Push-on Fastener -----	1

* Replaced by Ref. Nos. 52, 53 and 54 on new machines.

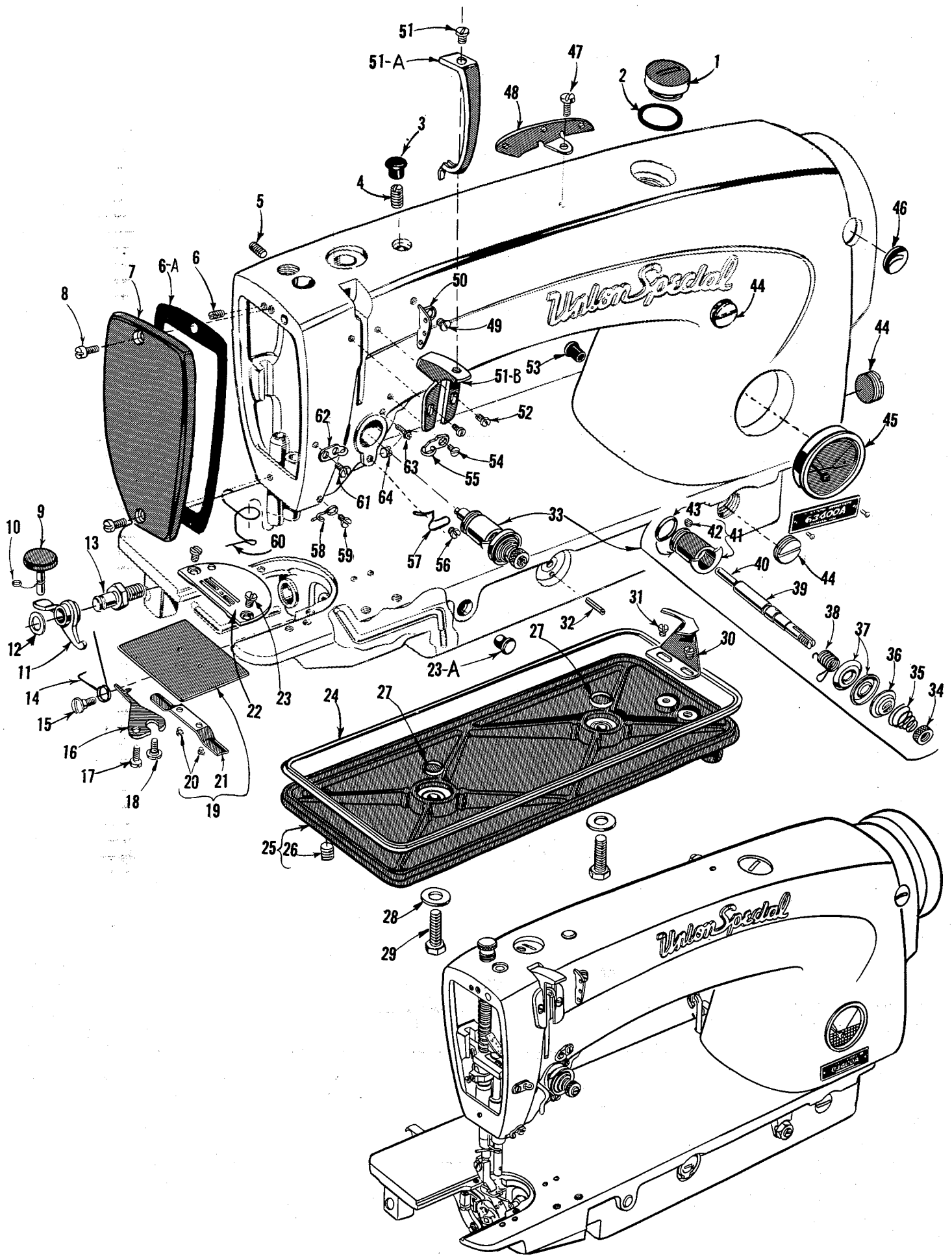

MAIN FRAME, MISCELLANEOUS COVERS AND NEEDLE TENSION PARTS

<u>Ref. No.</u>	<u>Part No.</u>	<u>Description</u>	<u>Amt. Req.</u>
1	22733 D	Plug Screw, for oil filler hole -----	1
2	63494 A	Gasket -----	1
3	63494 B	Plug, plastic -----	1
4	22815	Screw -----	1
5	22894 E	Screw -----	1
6	96	Screw -----	1
6A	63482 A	Gasket -----	1
7	61482 G	Head Cover -----	1
8	22516	Screw -----	2
9	61449 V	Stitch Regulating Plunger -----	1
10	660-254 A	Retainer Ring -----	1
11	61449 U	Stitch Regulating Pawl -----	1
12	660-254 B	Retainer Ring -----	1
13	61449 Y	Stitch Regulating Pawl Stud -----	1
14	61449 X	Pawl Plunger Spring -----	1
15	22504 A	Screw -----	1
16	61414 A	Bobbin Case Holder Positioning Finger -----	1
17	22528	Screw -----	1
18	22742	Screw -----	1
19	63402 B	Bed Slide -----	1
20	91 A	Screw -----	2
21	61273	Bed Slide Spring -----	1
22		Throat Plate (see pages of Feed Dogs and Throat Plates) -----	1
23	376	Screw -----	2
23A	63494 B	Plug, plastic -----	1
24	61482 J	Gasket -----	1
25	61482 H	Oil Reservoir Cover -----	1
26	22571 F	Plug Screw -----	1
27	660-204	"O" Ring -----	2
28	652-16	Washer -----	2
29	22644 K-64	Screw -----	2
30	61494 R	Oil Distributing Plate -----	1
31	22570	Screw -----	2
32	660-219 A	Roll Pin -----	1
33	29475 AS	Tension Assembly -----	1
34	61292 C	Tension Nut -----	1
35	61392 F-9	Tension Spring -----	1
36	61492 H	Tension Release Washer -----	1
37	109	Tension Disc -----	2
38	63453	Take-up Spring -----	1
39	61492 F	Tension Post -----	1
40	61492 G	Tension Release Pin -----	1
41	61492 E	Tension Post Socket -----	1
42	22560 G	Set Screw -----	1
43	660-269 A	"Quad" Ring -----	1
44	22539 P	Plug Screw -----	3
45	63494 K	Oil Gauge -----	1
46	61449 T	Stitch Length Indicator -----	1
47	22570 A	Screw -----	1
48	61470 D	Frame Thread Eyelet -----	1
49	22805	Screw -----	1
50	61471 A	Frame Thread Eyelet -----	1
51	22564 B	Screw -----	1
51A	63451	Take-up Shield -----	1
51B	61471 B	Take-up Lever Hood -----	1
52	22562	Screw -----	2
53	63494 B	Plug, plastic -----	1
54	22766	Screw -----	1
55	61470 C	Thread Guide -----	1
56	HS24 C	Screw -----	1
57	63492	Tension Post Eyelet -----	1
58	63470	Lower Thread Eyelet -----	1
59	90	Screw -----	1
60	63470 B	Needle Bar Bushing Thread Guide -----	1
61	222 D	Screw -----	1
62	63470 A	Upper Thread Eyelet -----	1
63	22863 B	Stop Screw, for tension assembly -----	1
64	22597 E	Set Screw, for tension assembly -----	1

From the library of: Diamond Needle Corp

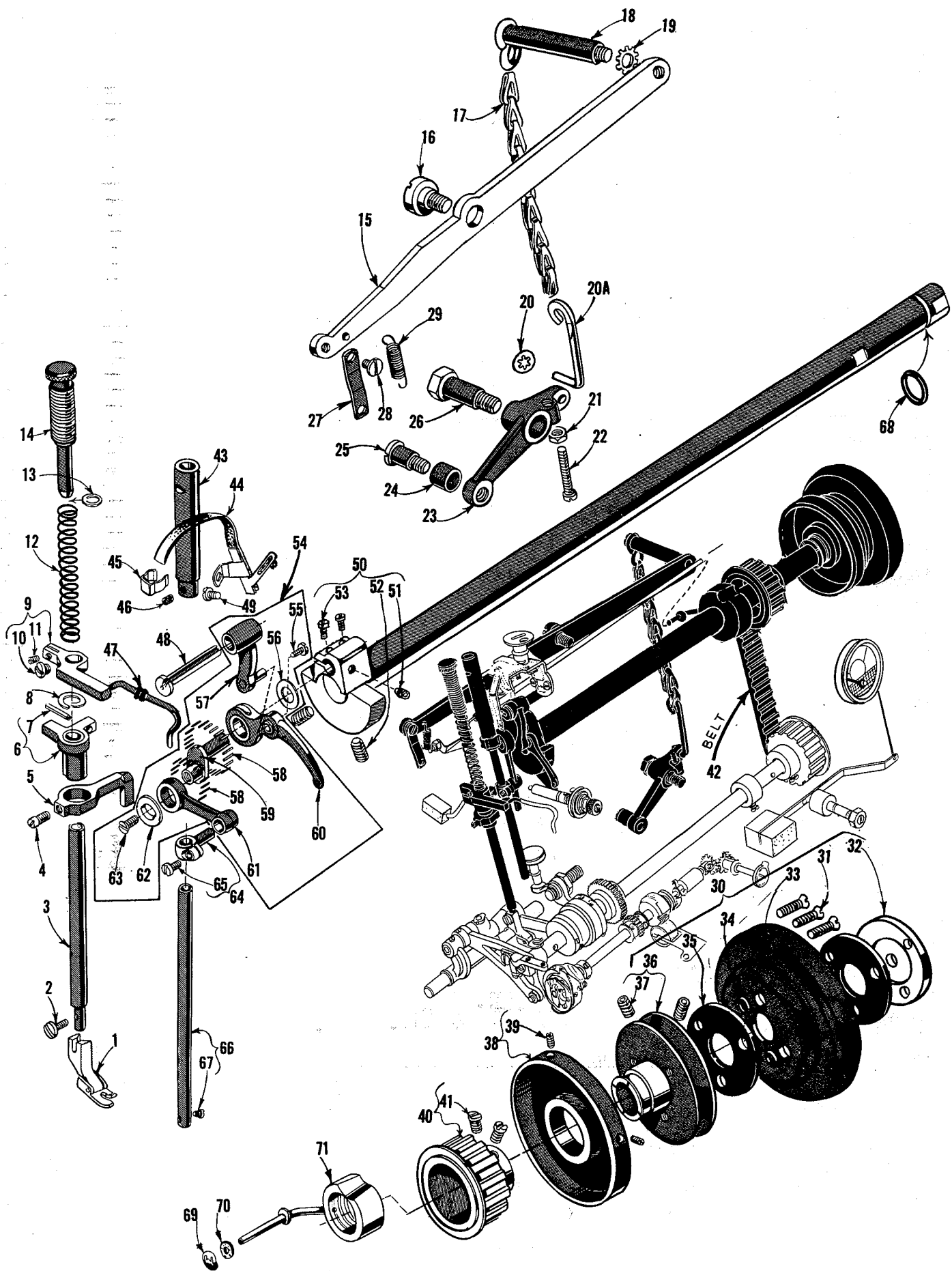

UPPER SHAFT, PRESSER BAR, NEEDLE BAR AND FOOT LIFTER MECHANISM

<u>Ref. No.</u>	<u>Part No.</u>	<u>Description</u>	<u>Amt. Req.</u>
1		Presser Foot (see pages of Presser Feet) -----	1
2	22775	Screw -----	1
3	63457 J	Presser Bar -----	1
4	230	Screw -----	1
5	61458 G	Tension Release Cam -----	1
6	61458 FA	Presser Bar Connection -----	1
7	660-219 B	Roll Pin -----	1
8	63457 R	Presser Bar Spring Washer -----	1
9	61459 C	Presser Bar Guide -----	1
10	22570	Screw -----	1
11	73 C	Set Screw -----	1
12	61356	Presser Spring -----	1
13	61256 G	Washer -----	1
14	61457 B	Presser Spring Regulator -----	1
15	63466	Lifter Lever -----	1
16	22890 A	Screw, left thread -----	1
17	421 H	Lifter Lever Chain -----	1
18	61468 B	Lifter Lever Extension Stud and Hook -----	1
19	652 B-20	Lock Washer -----	1
20	660-283 A	Fastener -----	1
20A	61468 D	Chain Hook -----	1
21	9937	Nut -----	1
22	22874 F	Screw -----	1
23	61468 F	Lifter Lever Bell Crank -----	1
24	61468 E	Bell Crank Roller -----	1
25	22712 G	Screw -----	1
26	22817 A	Screw -----	1
27	61467	Lifter Lever Link -----	1
28	22758 B	Screw -----	1
29	15872 F	Lifter Lever Spring -----	1
30	61421 B	Handwheel Assembly -----	1
31	22574 C	Screw -----	3
32	61421 G	Hub Washer -----	1
33	61421 C	Handwheel -----	1
34	660-254 D	Isolator Washer -----	3
35	61421 E	Handwheel Isolator -----	2
36	61421 D	Pulley -----	1
37	22894 V	Set Screw -----	2
38	61421 F	Stitch Length Indicator -----	1
39	22565 C	Set Screw -----	2
40	61460	Main Shaft Driving Sprocket -----	1
41	22884	Set Screw -----	2
42	61460 B	Feed Driving Belt -----	1
43	61454 A	Upper Needle Bar Bushing -----	1
44	63453 C	Oil Shield Diverting Felt -----	1
45	61454 B	Felt Holding Spring Clip -----	1
46	666-186	Oil Felt -----	1
47	660-254 C	"O" Ring -----	2
48	61451 B	Take-up Lever Pin -----	1
49	22564	Screw -----	1
50	29475 BC	Main Shaft Assembly, for Style 63400 A -----	1
	29475 BH	Main Shaft Assembly, for Style 63400 B -----	1
51	22894 U	Spot Screw -----	1
52	22894 V	Set Screw -----	2
53	22839	Screw -----	2
54	29486 L	Take-up Lever and Needle Bar Link Assembly -----	1
55	22784 E	Screw -----	1
56	61351 C	Thrust Washer -----	1
57	61451 A	Take-up Lever Link -----	1
58	61451 D-625	Needle Bearing, .0625 inch diameter -----	38
	61451 D-626	Needle Bearing, .0626 inch diameter -----	38
	61451 D-627	Needle Bearing, .0627 inch diameter -----	38
59	63452 A	Take-up Lever Crank Pin -----	1
60	61451	Take-up Lever -----	1
61	61455	Needle Bar Link -----	1
62	63455	Thrust Washer -----	1
63	22757 D	Screw -----	1
64	61255	Needle Bar Connection -----	1
65	22562 B	Screw -----	1
66	61417 E	Needle Bar -----	1
67	22768 A	Needle Set Screw -----	1
68	660-269	"Quad" Ring -----	1
69	660-456	Push-on Fastener -----	1
70	666-273	Felt Disc -----	1
71	63493 J	Oil Siphon Assembly -----	1

From the library of: Diamond Needle Corp

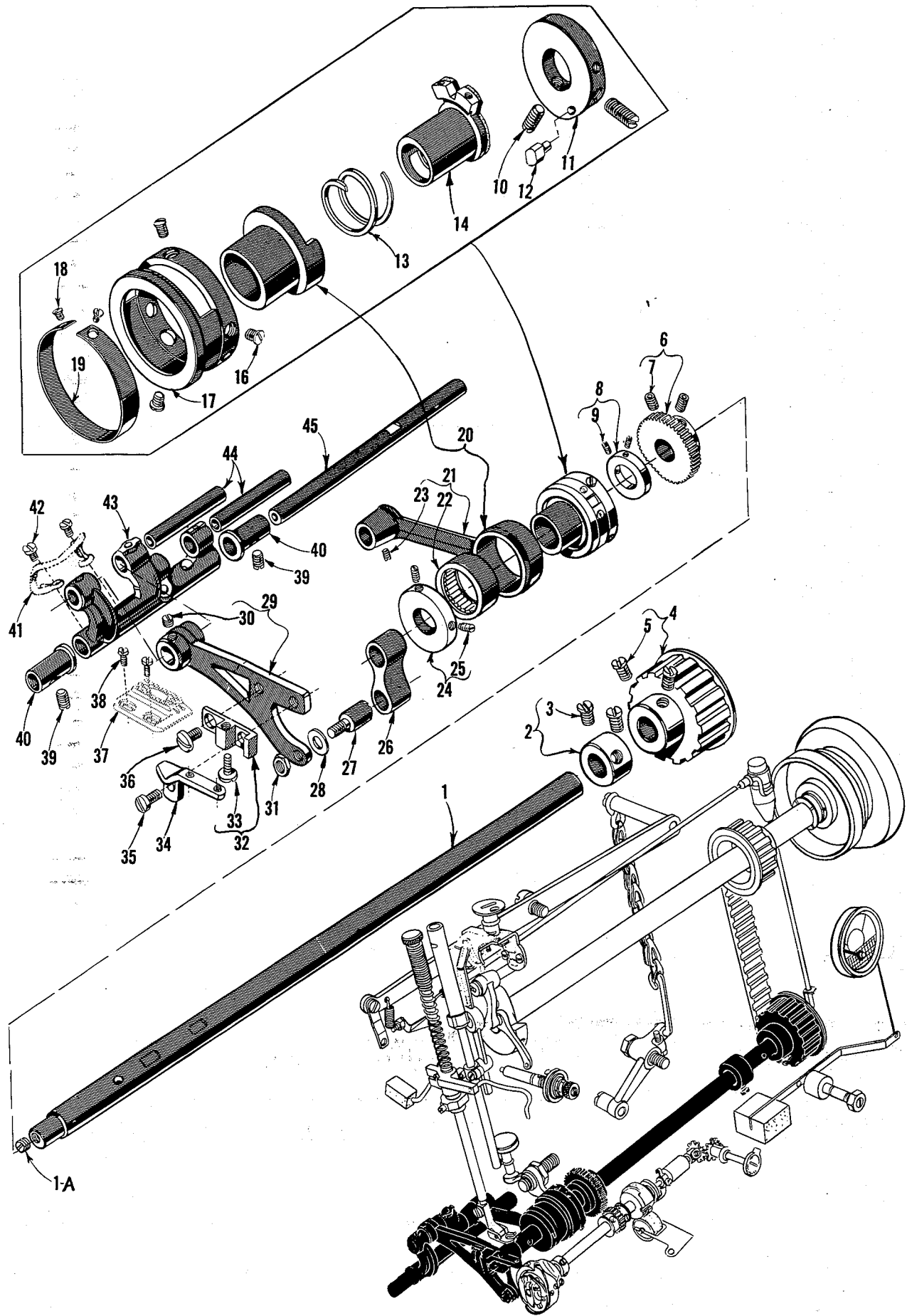

FEED DRIVING AND STITCH REGULATING MECHANISM

<u>Ref. No.</u>	<u>Part No.</u>	<u>Description</u>	<u>Amt. Req.</u>
1	61432 H	Feed Driving Shaft-----	1
1A	22586	Screw-----	1
2	61360 G	Thrust Collar-----	1
3	22884	Screw-----	2
4	61460 A	Feed Driving Shaft Sprocket-----	1
5	22653 D-6	Screw-----	2
6	63443	Hook Shaft Driving Gear-----	1
7	22894 C	Set Screw-----	2
8	61432 J	Collar-----	1
9	73 C	Set Screw-----	2
10	719	Screw-----	2
11	61437 A	Feed Driving Eccentric Timing Collar-----	1
12	61437 B	Feed Driving Eccentric Pivot Pin-----	1
13	61449 B	Stitch Regulating Eccentric Thrust Spring-----	1
14	61449 S	Stitch Regulating Eccentric-----	1
16	22564 H	Screw-----	3
17	61437 L	Feed Drive Eccentric Retainer Housing-----	1
18	22716 A	Screw-----	2
19	61437 M	Retainer Housing Spring Cover-----	1
20	29126 DD	Feed Driving Eccentric and Connecting Rod Assembly--	1
21	61438 B	Feed Driving Eccentric Connecting Rod-----	1
22	660-225	Needle Bearing-----	1
23	88	Set Screw-----	1
24	61437 N	Feed Driving Eccentric Thrust Collar-----	1
25	12935 A	Set Screw-----	2
26	63433 A	Feed Lift Link-----	1
27	22845 K	Feed Lift Link Stud-----	1
28	61434 G	Washer-----	1
29	63434 C	Feed Bar-----	1
30	89	Set Screw-----	1
31	15037 A	Nut-----	1
32	63439 AL	Feed Dog Holder Support-----	1
33	22775 A	Screw-----	1
34	63439 A	Feed Dog Holder-----	1
35	22528	Screw-----	1
36	88 D	Screw-----	1
37		Feed Dog (See pages of Feed Dogs and Throat Plates)---	1
38	22768	Screw-----	2
39	22894 J	Screw-----	2
40	61336 U	Feed Rocker Shaft Bushing-----	2
41	61336 Y	Feed Rocker Oil Wick-----	1
42	90	Screw-----	2
43	61236	Feed Rocker-----	1
44	63435 A	Feed Bar Shaft-----	2
45	61236 G	Feed Rocker Shaft-----	1

From the library of: Diamond Needle Corp

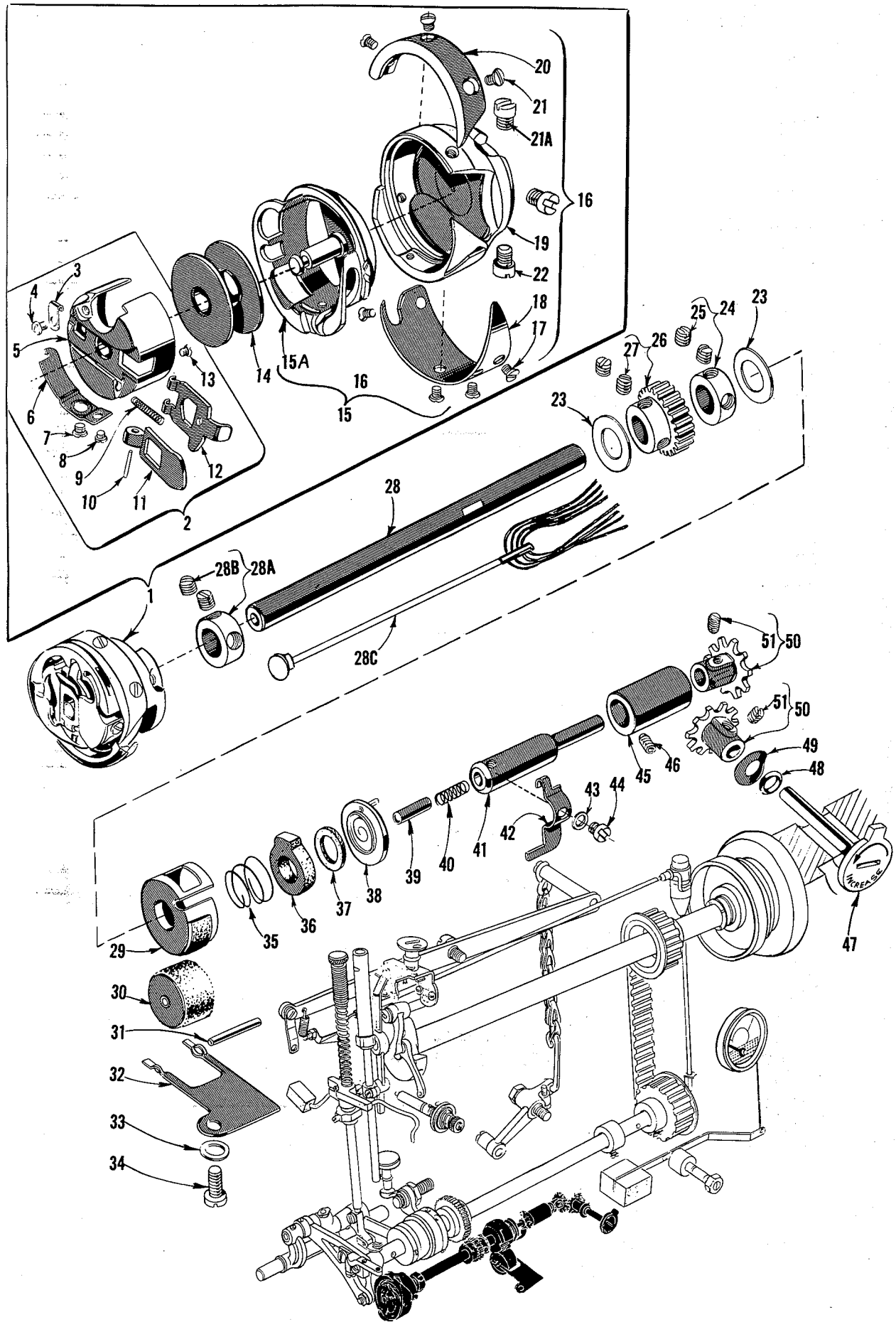

ROTATING HOOK ASSEMBLY AND HOOK OILING PARTS

<u>Ref. No.</u>	<u>Part No.</u>	<u>Description</u>	<u>Amt. Req.</u>
1	29474 P	Rotating Hook Assembly -----	1
2	61413 E	Bobbin Case Assembly -----	1
3	61413 G	Eyelet -----	1
4	22564 F	Screw -----	1
5	61413 F	Bobbin Case -----	1
6	61414 C	Bobbin Case Tension Spring -----	1
7	22716 B	Tension Regulating Screw -----	1
8	22564 E	Screw -----	1
9	61216 N	Bobbin Case Latch Spring -----	1
10	61216	Bobbin Case Latch Hinge Pin -----	1
11	61415 A	Bobbin Case Latch Lever -----	1
12	61415	Bobbin Case Latch -----	1
13	22564 E	Stop Screw -----	1
14	61212	Bobbin -----	1
15	63407	Hook, Thread Retainer, Thread Deflector and Bobbin Case Holder Assembly -----	1
15A	63414	Bobbin Case Holder -----	1
16	63407 A	Hook, Thread Retainer and Thread Deflector Assembly -----	1
17	22716 A	Screw -----	4
18	61210 B	Hook Thread Deflector -----	1
19	63408	Hook -----	1
20	61411 A	Hook Thread Retainer -----	1
21	22716 H	Screw -----	3
21A	22565 M	Screw -----	1
22	22569 H	Set Screw -----	2
23	61351 C	Thrust Washer -----	2
24	12865	Thrust Collar -----	1
25	88	Screw -----	2
26	61444	Hook Shaft Pinion -----	1
27	89	Screw -----	2
28	61440	Hook Shaft -----	1
28A	63432	Thrust Collar -----	1
28B	HA73 B	Set Screw -----	2
28C	61496 V	Hook Shaft Wick Insert Assembly -----	1
29	63496 B	Metering Cup -----	1
30	61496 E	Hook Oil Feed Roller -----	1
31	61496 G	Pivot Pin -----	1
32	61496 F	Retaining Spring -----	1
33	53678 N	Washer -----	1
34	22516 B	Screw -----	1
35	61496 J	Air Seal Spring -----	1
36	666-181	Oil Supply Felt -----	1
37	666-182	Air Seal Felt -----	1
38	61496 C	Pump Disc -----	1
39	61496 D	Pump Disc Pivot Pin -----	1
40	35857 R	Spring -----	1
41	61496 L	Hook Oil Control Shaft -----	1
42	61496 K	Hook Oil Control Finger -----	1
43	27-527 Blk.	Washer -----	1
44	22819	Screw -----	1
45	61496 P	Hook Oil Control Shaft Bushing -----	1
46	22894 R	Set Screw, for No. 61496 P -----	1
47	61496 N	Oil Control Adjusting Shaft -----	1
48	660-221	Oil Seal Ring -----	1
49	39198 D	Spring Washer -----	1
50	61496 M	Oil Control Cog -----	2
51	22743	Set Screw -----	1

From the library of: Diamond Needle Corp

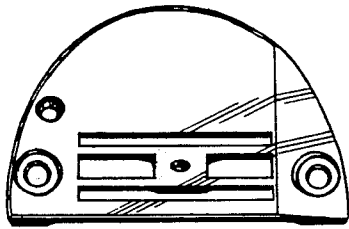

61324 J

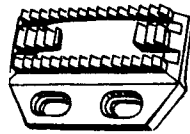

61305 K

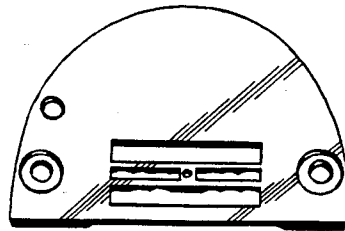

L580

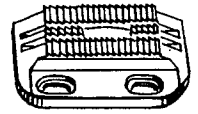

L579

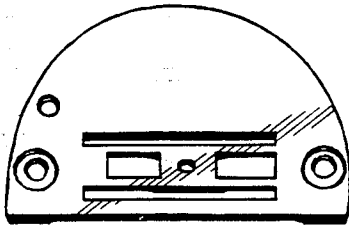

61424 C

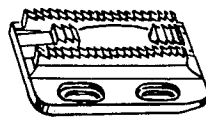

61405 C

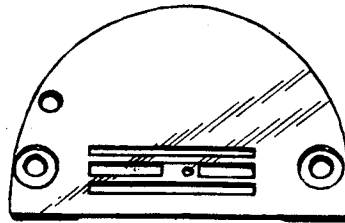

61424 Y

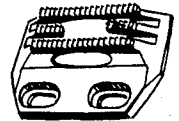

61405 Y

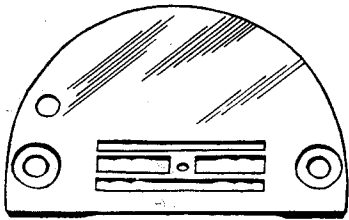

61224 F

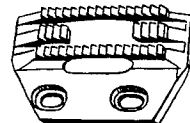

61205 D

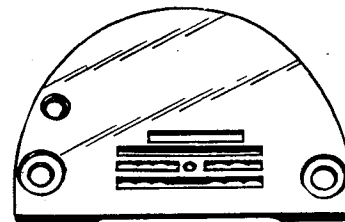

61424 J

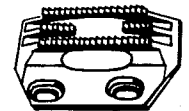

61405 J

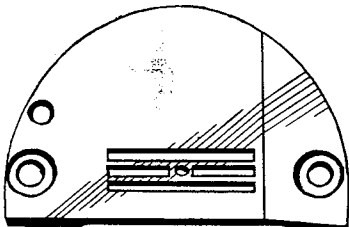

61324 Q

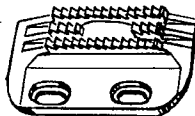

61305 Q

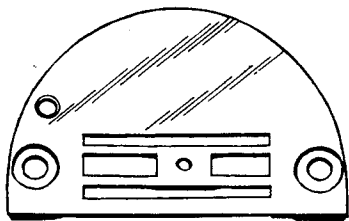

61324 L

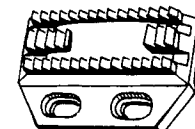

61305 M

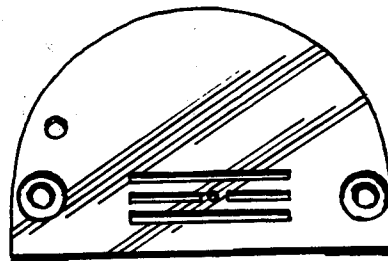

61224 C

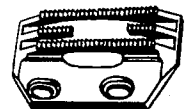

61205 C

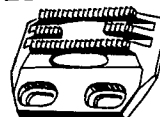

61305 S

THROAT PLATE AND FEED DOG COMBINATIONS

<u>Part No.</u>	<u>Description</u>
L579	Teeth cut 22 per inch, for edge stitching pockets; throat plate No. L580, presser foot No. 61220 W
L580	With .063 inch needle hole, for edge stitching pockets and similar operations; feed dog No. L579, presser foot No. 61220 W (.085 inch thick)
61205 C	Teeth cut 22 per inch, for plain seaming on dress shirts, blouses, dresses and other light weight material; throat plate Nos. 61224 C-043, 61224 C-063, presser foot No. 61220 J
61205 D	Teeth cut 16 per inch, for setting pockets on shirts; throat plate No. 61224 F-063, presser foot No. 61320 AH, 61320 AJ
61224 C-043	With .043 inch needle hole, for seaming and hemming silk and rayon; .063 inch needle hole for seaming dresses; also in sizes .073 and .083 inch needle hole for seaming work shirts and dress pants; feed dog Nos. 61205 C, 61305 S, presser foot No. 61220 J (.085 inch thick)
61224 F-063	With .063 inch needle hole, for setting pockets of dress shirts, also in sizes .083, .093 inch needle holes, for work shirts; feed dog No. 61205 D, presser foot Nos. 61320 AH, 61320 AJ (.085 inch thick)
61305 K	Teeth cut 12 per inch, for seaming heavy weight trousers, coats, and similar garments; throat plate No. 61324 J-093, presser foot No. 61320 S
61305 M	Teeth cut 12 per inch, for seaming heavy coats and trousers; throat plate No. 61324 L-093, presser foot No. 61320 S
61305 Q	Teeth cut 16 per inch, for pants fly operation, using folder No. L186; throat plate No. 61324 Q-073, presser foot No. 61220
61305 S	Teeth cut 32 per inch, for miscellaneous seaming on silks, rayons; throat plate No. 61224 C-043, presser foot No. 61220 J
61324 J-093	With .093 inch needle hole, for seaming heavy weight trousers, coats, and similar garments; feed dog No. 61305 K, presser foot No. 61320 S (.125 inch thick)
61324 L-093	With .093 inch needle hole, for seaming heavy coats, trousers, and similar operations; feed dog No. 61305 M, presser foot No. 61320 S (.085 inch thick)
61324 Q-073	With .073 inch needle hole, for pants fly operations using folder No. L186; feed dog No. 61305 Q, presser foot No. 61220 (.125 inch thick)
61405 C	Teeth cut 16 per inch, for sewing pocket facings with chaining between pockets, throat plate No. 61424 C-093, presser foot No. 61420 C
61405 J	Teeth cut 22 per inch, for top stitching shirt collars; throat plate No. 61424 J-063, presser foot No. 61420 AH
61405 Y	Teeth cut 22 per inch, for hemming shirts, throat plate No. 61424 Y-063, presser foot No. 61220 J
61424 C-093	With .093 inch needle hole, for sewing pocket facings with chaining between pockets; feed dog No. 61405 C, presser foot No. 61420 C (.125 inch thick)
61424 J-063	With .063 inch needle hole, for top stitching shirt collars; feed dog No. 61405 J, presser foot No. 61420 AH (.085 inch thick)
61424 Y-063	With .063 inch needle hole, for hemming shirts, .073 inch needle hole also available; feed dog No. 61405 Y, presser foot No. 61220 J (.085 inch thick)

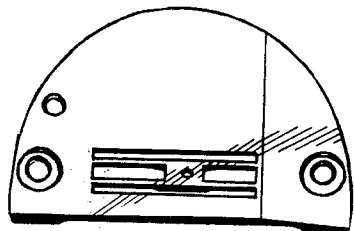

61424 S

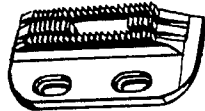

61405 S

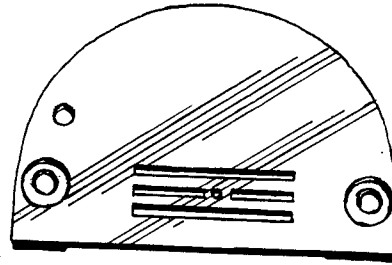

61224 C

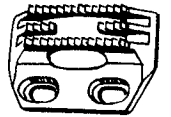

61205 A

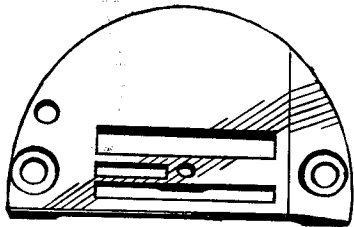

61424 G

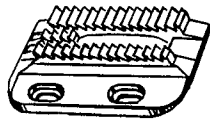

61405 G

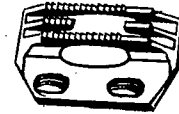

61205 CA

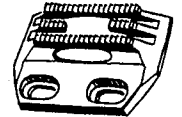

61205 C

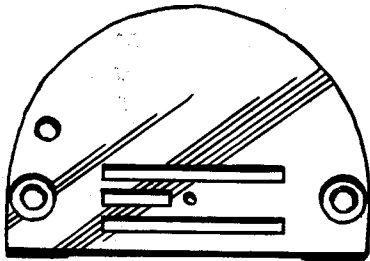

61324 D

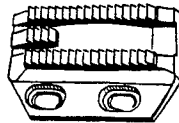

61305 F

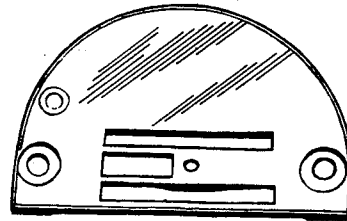

61424 N

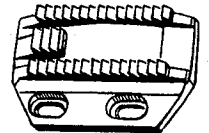

61405 N

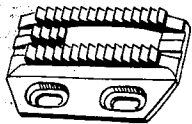

61305 D

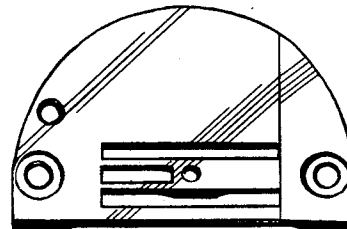

61324 R

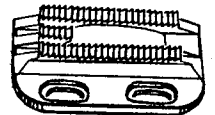

61305 T

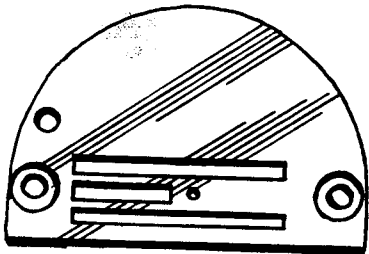

61324 C

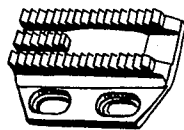

61305 C

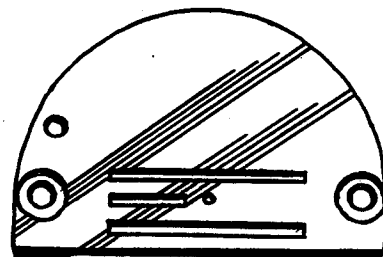

61324 A

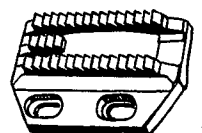

61305 A

THROAT PLATE AND FEED DOG COMBINATIONS

<u>Part No.</u>	<u>Description</u>
61205 A	Teeth cut 16 per inch, for plain seaming on work shirts, dress and semi-dress pants; throat plate No. 61224 C-073, presser foot No. 61220 J, 61320 AB
61205 C	Teeth cut 22 per inch, for plain seaming on dress shirts, blouses, dresses and other light material; throat plate No. 61224 C-043, 61224 C-063, presser foot No. 61220 J
61205 CA	Teeth cut 22 per inch, for hemming shirts, using hemmer No. L96, throat plate No. 61224 C-073, presser foot No. 61220 J
61224 C-063	With .063 inch needle hole, for seaming dresses; also in sizes .073, .083 inch needle hole for seaming work shirts and dress pants; feed dog No. 61205 A, 61205 C, 61205 CA, presser foot No. 61220 C, 61220 J, 61320 AB (.085 inch thick)
61305 A	Teeth cut 14 per inch, for miscellaneous operations on work pants, dungarees and overalls; throat plate No. 61324 A-093, presser foot No. 61220 P
61305 C	Teeth cut 14 per inch, for hemming high back overall suspenders; throat plate No. 61324 C-093, presser foot No. 61320 C
61305 D	Teeth cut 14 per inch, for miscellaneous seaming operations; throat plate No. 61324 D-093, presser foot No. 61320 AA
61305 F	Teeth cut 16 per inch, for miscellaneous operations on light weight material; throat plate No. 61324 D-073, presser foot No. 61320 AA
61305 T	Teeth cut 22 per inch, for miscellaneous seaming operations on coats and pants; throat plate No. 61324 R-093, presser foot No. 61220 P
61324 A-063	With .063 inch needle hole, for miscellaneous operations on work pants, dungarees and overalls; also in sizes .093, .125 inch needle holes; feed dog No. 61305 A, presser foot No. 61220 P (.125 inch thick)
61324 C-083	With .083 inch needle hole, for hemming high back overall suspenders; also in sizes .093, .125 inch needle holes; feed dog No. 61305 C, presser foot No. 61320 C (.125 inch thick)
61324 D-063	With .063 inch needle hole, for tacking flies to overalls and similar operations; also in sizes .073, .083, .093 inch needle holes; feed dog No. 61305 D, 61305 F, presser foot No. 61320 Q (.085 inch thick)
61324 R-073	With .073 inch needle hole, for seaming operations on coats and pants; also in size .093 inch needle hole; feed dog No. 61305 T, presser foot No. 61220 P (.125 inch thick)
61405 G	Teeth cut 14 per inch, for cording couch covers; throat plate No. 61424 G-093, presser foot No. L220
61405 N	Teeth cut 14 per inch, for miscellaneous seaming operation on denim, canvas and other heavy materials; throat plate No. 61424 N-093, presser foot No. 61320 AA
61405 S	Teeth cut 22 per inch, for run stitching collar operations; throat plate No. 61424 S-063, presser foot No. 61420 BJ
61424 G-093	With .093 inch needle hole for cording couch covers and similar operations; feed dog No. 61405 G, presser foot No. L220 (.125 inch thick)
61424 N-093	With .093 inch needle hole, for miscellaneous operations on denim, canvas and other heavy weight materials; feed dog No. 61405 N, presser foot No. 61320 AA (.125 inch thick)
61424 S-063	With .063 inch needle hole, for run stitching collar operations on dress and work shirts, feed dog No. 61405 S, presser foot No. 61420 BJ (.125 inch thick)

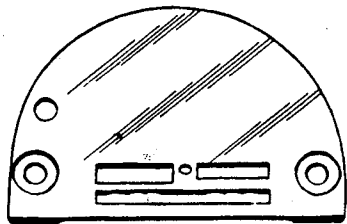

61224 E



61205 E

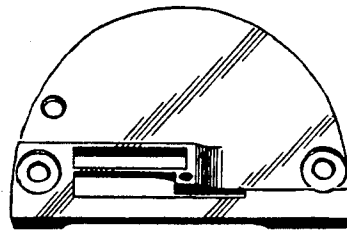

61324 U

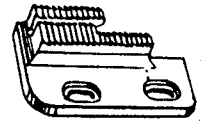

61305 U

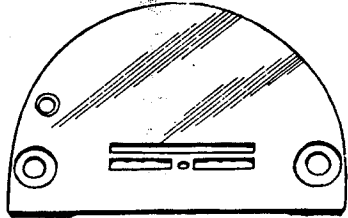

61424 M

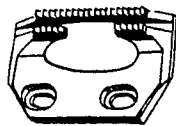

61405 M

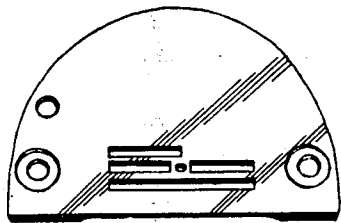

61424 X

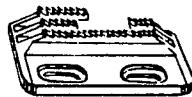

61405 X

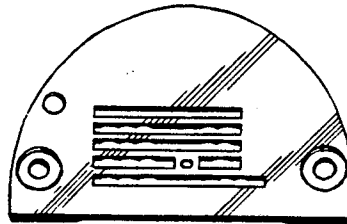

61424 AM

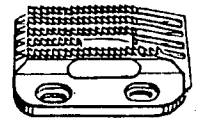

61405 AN

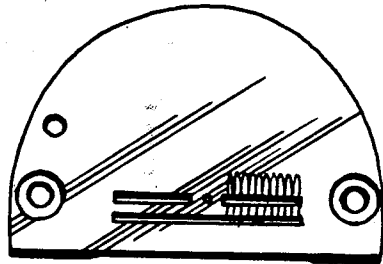

61224 B

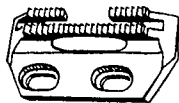

61405 Z

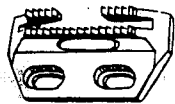

61205 B

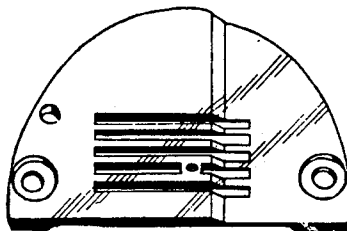

61424 K

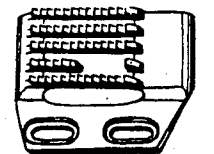

61405 K

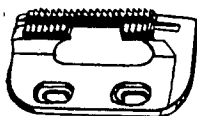

61405 H

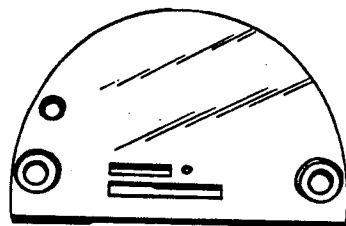

L391

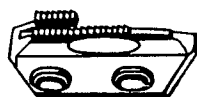

L369

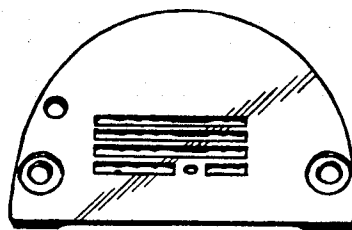

L549

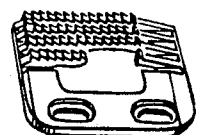

L550

THROAT PLATE AND FEED DOG COMBINATIONS

<u>Part No.</u>	<u>Description</u>
L369	Teeth cut 22 per inch, for hemming handkerchiefs; throat plate No. L391, presser foot No. 61320 AJ
L391	With .063 inch needle hole, for hemming handkerchiefs; feed dog No. L369, presser foot No. 61320 AJ (.085 inch thick)
L549	With .073 inch needle hole for attaching sleeve facings to work shirts; feed dog No. L550, presser foot No. 61420 H (.125 inch thick)
L550	Teeth cut 16 per inch, for attaching sleeve facings to work shirts; throat plate No. L549, presser foot No. 61420 H
61205 B	Teeth cut 16 per inch, for hemming work shirts, dresses and similar garments; throat plate No. 61224 B-063, presser foot No. 61220 B, 61220 C
61205 E	Teeth cut 16 per inch, for hemming work shirts; throat plate No. 61224 E-063, presser foot No. 61420 BN (use with plate hemmer)
61224 B-063	With .063 inch needle hole, for hemming house dresses; also in size .093 inch needle hole for work shirts, feed dog No. 61205 B, 61405 Z, presser foot No. 61220 B; 61220 C (.085 inch thick)
61224 E-063	With .063 inch needle hole, for hemming work shirts; feed dog No. 61205 E, presser foot No. 61420 BN (use with plate hemmer) (.085 inch thick)
61305 U	Teeth cut 22 per inch, for hemming work shirts and binding plastics; throat plate No. 61324 U-063, presser foot No. 61420 BN, L82 A
61324 U-063	With .063 inch needle hole, for hemming work shirts; feed dog No. 61305 U, presser foot No. 61420 BN, L82 A (.156 inch thick)
61405 H	Teeth cut 22 per inch for binding and hemming flannel shirts; throat plate No. 61424 H-063, presser foot No. L380
61405 K	Teeth cut 16 per inch, for sleeve facings on sport and work shirts; throat plate No. 61424 K-063, presser foot No. 61420 H
61405 M	Teeth cut 22 per inch, for attaching yokes to shirts; throat plate No. 61424 M-063, presser foot No. 61420 BD
61405 X	Teeth cut 22 per inch, for hemming on rayon; throat plate No. 61424 X-063, presser foot No. 61420 X
61405 Z	Teeth cut 22 per inch, for edge stitching pockets on dresses, shirts and similar garments; throat plate No. 61224 B-063, presser foot No. 61420 AJ
61405 AN	Teeth cut 22 per inch, for miscellaneous edge stitching with 1/2 inch margin; throat plate Nos. 61424 AM-053 or 61424 AM-063, presser foot Nos. 61420 AM, 61420 CM
61424 K-063	With .063 inch needle hole, for sleeve facings on sport and work shirts; feed dog No. 61405 K, presser foot No. 61420 H (.109 inch thick at front and .203 inch thick at back)
61424 M-063	With .063 inch needle hole, for attaching yokes to shirts; feed dog No. 61405 M, presser foot No. 61420 BD (.085 inch thick)
61424 X-063	With .063 inch needle hole, for hemming rayon material; feed dog No. 61405 X, presser foot No. 61420 X (.085 inch thick)
61424 AM-053	With .053 inch needle hole; also in size .063 inch needle hole for edge stitching shirts and dresses; feed dog No. 61405 AN, presser foot Nos. 61420 AM, 61420 CM (.085 inch thick)

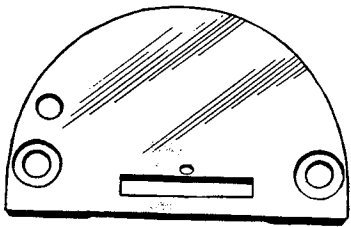

L54

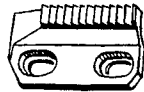

L55

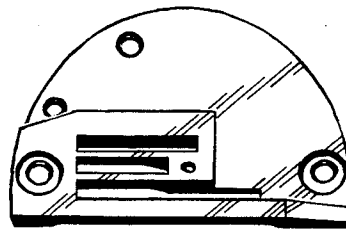

L437

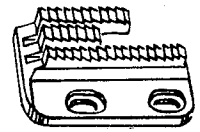

L438

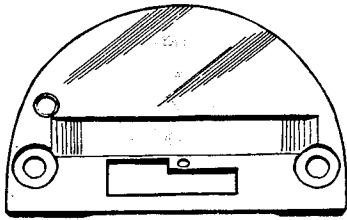

L222

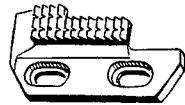

L223

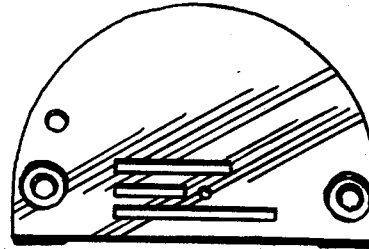

61324

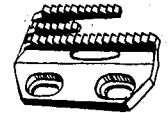

61305

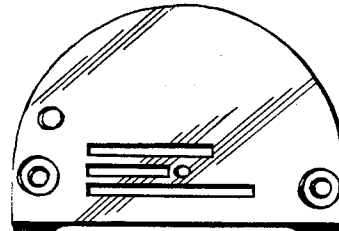

61324 N

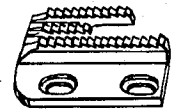

61305 N

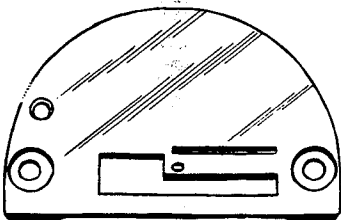

L28

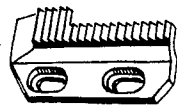

L29

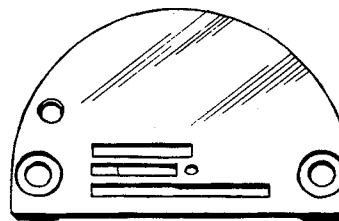

61424 L

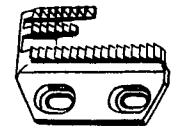

61405 L

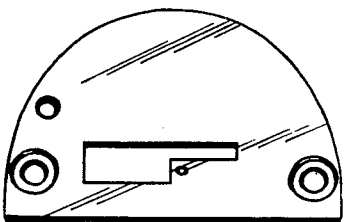

61424 R

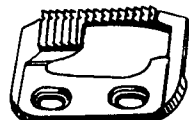

61405 R

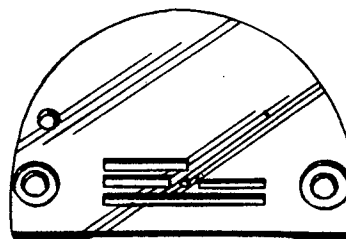

61424 AH



61405 AH

THROAT PLATE AND FEED DOG COMBINATIONS

<u>Part No.</u>	<u>Description</u>
L28	With .063 inch needle hole, for miscellaneous hemming operations; feed dog No. L29, presser foot No. L30 (.085 inch thick)
L29	Teeth cut 16 per inch, for miscellaneous hemming operations; throat plate No. L28, presser foot No. L30
L54	With .063 inch needle hole, for miscellaneous seaming on leather; feed dog No. L55, presser foot No. 61420 BA; also for use with roller presser foot swing-out assembly No. K67092 (.085 inch thick)
L55	Teeth cut 16 per inch, for miscellaneous seaming on leather; throat plate No. L54, presser foot No. 61420 BA; also for use with roller presser foot swing-out assembly No. K67092
L222	With .063 inch needle hole, for top stitching collars of dress shirts; feed dog No. L223, presser foot No. L768 (.085 inch thick)
L223	Teeth cut 16 per inch, for top stitching collars of dress shirts; throat plate No. L222, presser foot No. L768
L437	With .083 inch needle hole, for binding operation on jackets; feed dog No. L438, presser foot No. L440 (.090 inch thick at front and on right and .190 inch thick at back)
L438	Teeth cut 16 per inch, for binding operation on jackets; throat plate No. L437, presser foot No. L440
61305	Teeth cut 16 per inch, for miscellaneous operations on cotton and wool trousers; throat plate No. 61324-093, presser foot No. 61320 B
61305 N	Teeth cut 16 per inch, for miscellaneous operations on work shirts; throat plate No. 61324 N-063, presser foot No. 61320 R
61324-063	With .063 inch needle hole, for miscellaneous operations on cotton and wool trousers; also in sizes .073, .093 inch needle holes; feed dog No. 61305, presser foot No. 61320 B (.085 inch thick)
61324 N-063	With .063 inch needle hole, for miscellaneous operations on work shirts; also in sizes .073, .093 inch needle holes feed dog No. 61305 N, presser foot No. 61320 R (.125 inch thick)
61405 L	Teeth cut 16 per inch, for binding rayon material; throat plate No. 61424 L-063, presser foot No. 61420 BE
61405 R	Teeth cut 16 per inch, for sewing zipper tabs to pants flies; throat plate No. 61424 R-073, presser foot No. 61420 V
61405 AH	Teeth cut 22 per inch, for top stitching collars and cuffs on dress and sport shirts and wash and wear material; throat plate No. 61424 AH-063, L253 compound presser bar assembly, 63430 D presser foot bottom
61424 L-063	With .063 inch needle hole, for binding rayon; feed dog No. 61405 L, presser foot No. 61420 BE (.085 inch thick)
61424 R-073	With .073 inch needle hole, for sewing zipper tabs to pants flies; feed dog No. 61405 R, presser foot No. 61420 V (.085 inch thick)
61424 AH-063	With .063 inch needle hole, for top stitching collars and cuffs on dress and sport shirts and wash and wear material: feed dog No. 61405 AH, L253 compound presser bar assembly, presser foot bottom No. 63430 D (.085 inch thick)

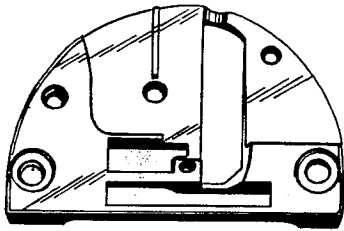

61424 T

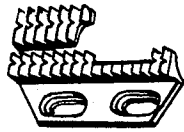

61405 T

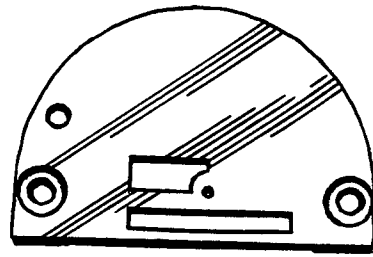

61324 B

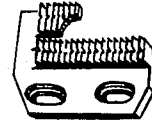

L916

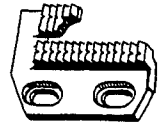

61305 B

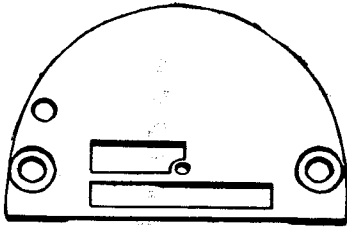

61424 U

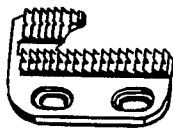

61405 U

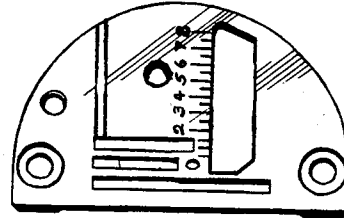

61424 Z

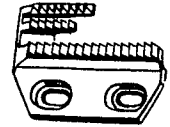

61405 L

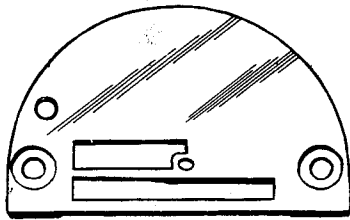

61324 E

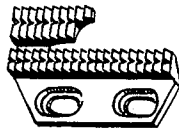

61305 E

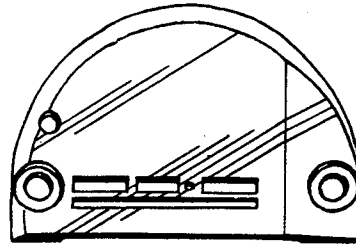

61424 AE

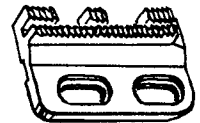

61405 AE

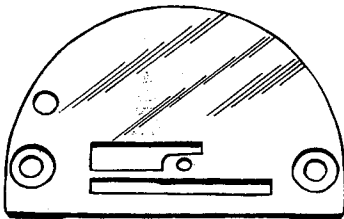

61324 F

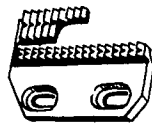

61305 G

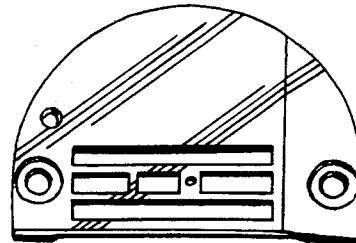

61424 AA

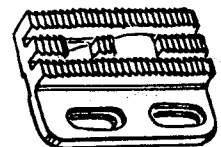

61405 AA

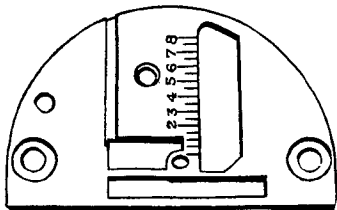

61224 D

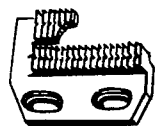

61305 B

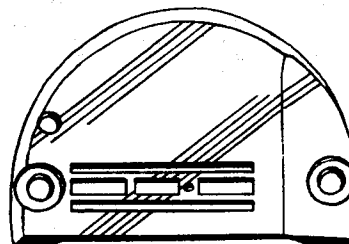

61424 AB

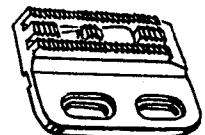

61405 AB

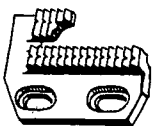

L916

THROAT PLATE AND FEED DOG COMBINATIONS

<u>Part No.</u>	<u>Description</u>
L916	Teeth cut 22 per inch, for sewing bias strips on dresses and similar materials; throat plate Nos. 61224 D-063, 61324 B-063, presser foot No. 61220 H
61224 D-063	With .063 inch needle hole, for binding operations, used with English type binder; also in size .073 inch needle hole; feed dog Nos. 61305 B, 61305 H, L916, presser feet Nos. 61220 H, 61320 (.085 inch thick)
61305 B	Teeth cut 16 per inch, for edge stitching on suit coats and vests; throat plate No. 61324 B-063, presser foot No. 61320
61305 E	Teeth cut 16 per inch, for miscellaneous operations on coats and pants; throat plate No. 61324 E-063, presser foot No. L266
61305 G	Teeth cut 16 per inch, for edge stitching coats and vests; throat plate No. 61324 F-093, presser feet Nos. 61320, L290
61324 B-063	With .063 inch needle hole, for edge stitching on suits, coats and vests; also in sizes .073, .083, .093 inch needle holes; feed dog Nos. 61305 B, L916, presser foot No. 61320 (.085 inch thick)
61324 E-063	With .063 inch needle hole, for miscellaneous operations on coats and pants, also in sizes .073, .093 inch needle holes; feed dog No. 61305 E, presser foot No. L266 (.085 inch thick)
61324 F-063	With .063 inch needle hole, for edge stitching coats and similar garments; also in size .093 inch needle hole; feed dog No. 61305 G, presser foot No. L290 (.085 inch thick)
61405 L	Teeth cut 16 per inch, for miscellaneous binding operations; throat plate No. 61424 Z-063, presser foot No. 61420 BE
61405 T	Teeth cut 16 per inch, for miscellaneous binding operations on heavy weight materials; throat plate No. 61424 T-093, presser foot No. 61220 H
61405 U	Teeth cut 16 per inch, for miscellaneous seaming on medium weight materials; throat plate No. 61424 U-093, presser foot No. 61220 P
61405 AA	Teeth cut 22 per inch, for miscellaneous seaming operations on medium weight wash and wear materials; throat plate No. 61424 AA-063, presser foot No. 61420 BU
61405 AB	Teeth cut 22 per inch, for miscellaneous seaming on light weight wash and wear materials; throat plate No. 61424 AB-063, presser foot No. 61420 AV
61405 AE	Teeth cut 22 per inch, for edge stitching on wash and wear materials; throat plate No. 61424 AE-063, presser foot No. 61420 BY
61424 T-093	With .093 inch needle hole, for miscellaneous binding operations; feed dog No. 61405 T, presser foot No. 61220 H (.125 inch thick)
61424 U-093	With .093 inch needle hole, for general seaming medium weight work; feed dog No. 61405 U, presser foot No. 61220 P (.085 inch thick)
61424 Z-063	With .063 inch needle hole, for miscellaneous binding operations; feed dog No. 61405 L, presser foot No. 61420 BE (.085 inch thick)
61424 AA-063	With .063 inch needle hole, for miscellaneous seaming operations on medium weight wash and wear materials, also in size .053 inch needle hole; feed dog No. 61405 AA, presser foot No. 61420 BU (.125 inch thick)
61424 AB-053	With .053 inch needle hole, for miscellaneous seaming on light weight wash and wear materials, also in size .063 inch needle hole; feed dog No. 61405 AB, presser foot No. 61420 BV (.125 inch thick)
61424 AE-053	With .053 inch needle hole, for edge stitching on wash and wear materials; feed dog No. 61405 AE, presser foot No. 61420 BY (.125 inch thick)

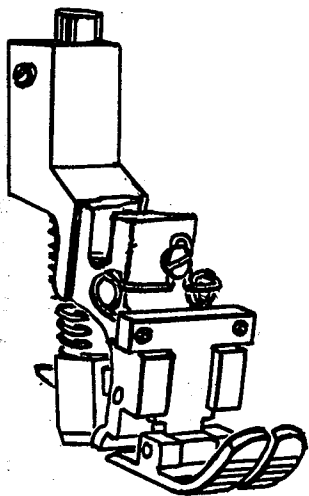

61420 BW

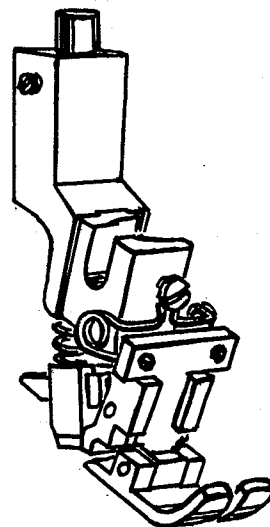

63420 D

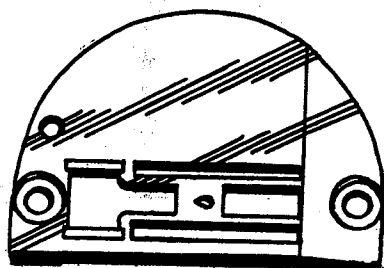

61424 AC

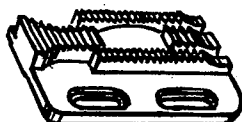

61405 AC



61405 AD

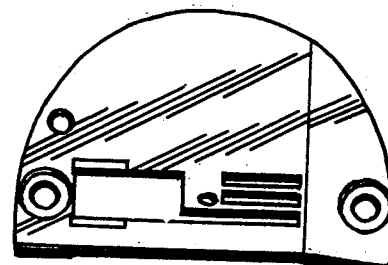

61424 AD



61430 AN

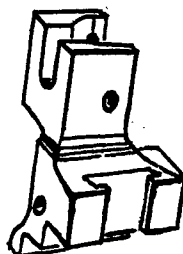

61430 AE



61430 CB



61430 AP

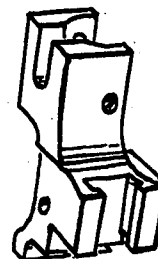

61430 AG

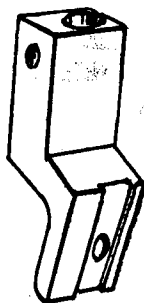

61430 AK



61430 AD

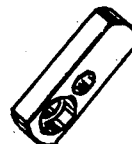

63471



57 WB



61430 AF



605



28 B



61430 AH



61330 B



HA73 B



57 WC



61430 CA



61430 AJ



57 WD



73 A



73 C



604



22564 B

AUTOMATIC CHAIN CUTTING COMBINATIONS AND NIPPER SPRING ASSEMBLY

<u>Part No.</u>	<u>Description</u>
28 B	Screw, for chain cutter No. 61430 AP
57 WB	Nipper Spring Plate, for automatic chain cutting assembly Nos. 29480 CR, 29480 CS and nipper spring assembly No. 21390 BE
57 WC	Nipper Spring, for automatic chain cutting assembly Nos. 29480 CR, 29480 CS and nipper spring assembly No. 21390 BE
57 WD	Nipper Spring Stud, for automatic chain cutting assembly Nos. 29480 CR, 29480 CS and nipper spring assembly No. 21390 BE
73 A	Screw, for spring No. 61430 AJ
73 C	Screw, for adjusting pin No. 61430 CB
HA73 B	Screw, for chain cutter No. 61430 AN
604	Screw, for spring guide No. 61430 AK on presser foot No. 61420 BW
605	Screw, for spring guide No. 61430 AK on presser foot No. 63420 D
21390 BE	Nipper Spring Assembly (nipper spring plate No. 57 WB, nipper spring No. 57 WC, nipper spring stud No. 57 WD, 22564 B attaching screw, 63471 nipper spring base, 63471 A bracket
22564 B	Screw, for nipper spring base No. 63471
29480 CR	Automatic Chain Cutting Assembly (nipper spring assembly No. 21390 BE, feed dog No. 61405 AC, throat plate No. 61424 AC-063, presser foot No. 61420 BW
29480 CS	Automatic Chain Cutting Assembly (nipper spring assembly No. 21390 BE, feed dog No. 61405 AD, throat plate No. 61424 AD-063, presser foot No. 63420 D
61330 B-29	Hinge Pin, 29/64 inch long for presser foot No. 63420 D
61330 B-39	Hinge Pin, 39/64 inch long for presser foot No. 61420 BW
61405 AC	Feed Dog, for automatic chain cutting assembly No. 29480 CR
61405 AD	Feed Dog, for automatic chain cutting assembly No. 29480 CS
61420 BW	Presser Foot, for automatic chain cutting assembly No. 29480 CR
61424 AC-063	Throat Plate, .063 inch needle hole for automatic chain cutting assembly No. 29480 CR
61424 AD-063	Throat Plate, .063 inch needle hole for automatic chain cutting assembly No. 29480 CS
61430 AD	Presser Foot Bottom, for presser foot No. 61420 BW
61430 AE	Presser Foot Shank, for presser foot No. 61420 BW
61430 AF	Presser Foot Bottom, for presser foot No. 63420 D
61430 AG	Presser Foot Shank, for presser foot No. 63420 D
61430 AH	Chain Cutter Spring, for presser feet Nos. 61420 BW, 63420 D
61430 AJ	Torsion Spring, for bottom on presser feet Nos. 61420 BW, 63420 D
61430 AK	Spring Guide, for presser feet Nos. 61420 BW, 63420 D
61430 AL	Yielding Section, for presser feet Nos. 61420 BW, 63420 D
61430 AN	Chain Cutter, marked "G" for presser foot No. 61420 BW
61430 AP	Chain Cutter, marked "H" for presser foot No. 63420 D
61430 CA	Adjustment Slide, for presser feet Nos. 61420 BW, 63420 D
61430 CB	Adjusting Pin, for presser feet Nos. 61420 BW, 63420 D
63420 D	Presser Foot, for automatic chain cutting assembly No. 29480 CS
63471	Nipper Spring Base, for automatic chain cutting assembly Nos. 29480 CR, 29480 CS and nipper spring assembly No. 21390 BE
63471 A	Nipper Spring Assembly Mounting Bracket, for nipper spring assembly No. 21390 BE

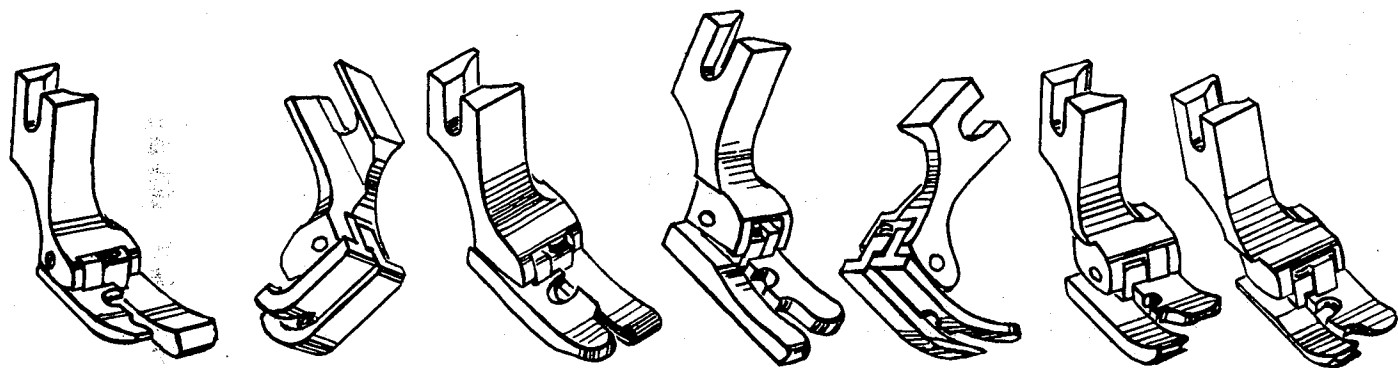

61420 AN L440 61220 S 61220 W 61320 AG 61320 AH 61320 AJ

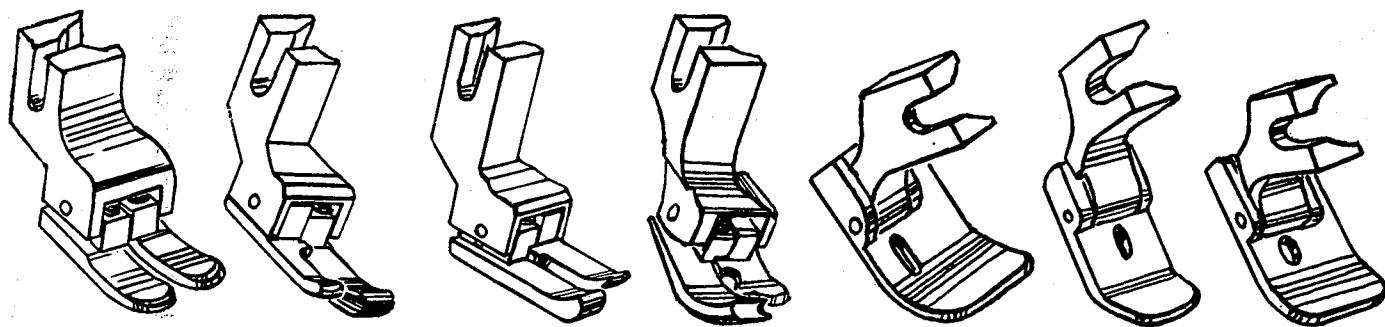

61420 61420 A 61420 B L498 A 61220 K 61220 61220 Q

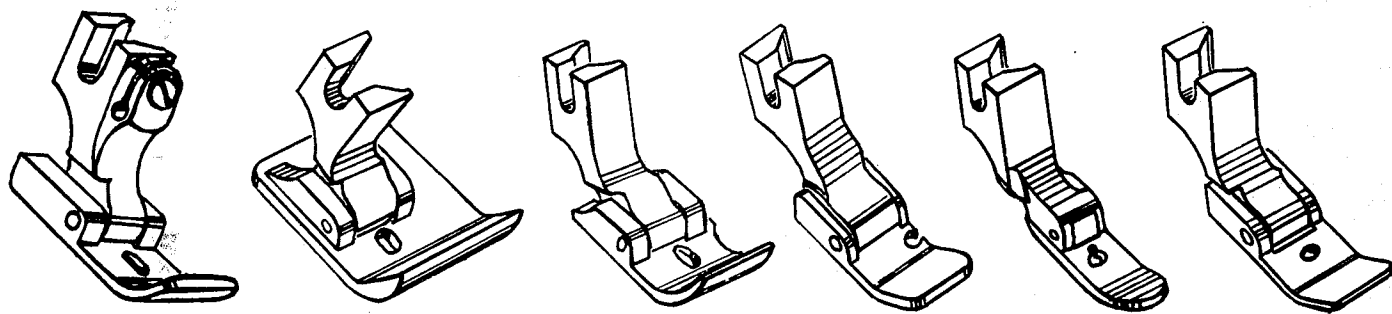

L86 A L412 61420 AP 61420 AR 61420 AT L525

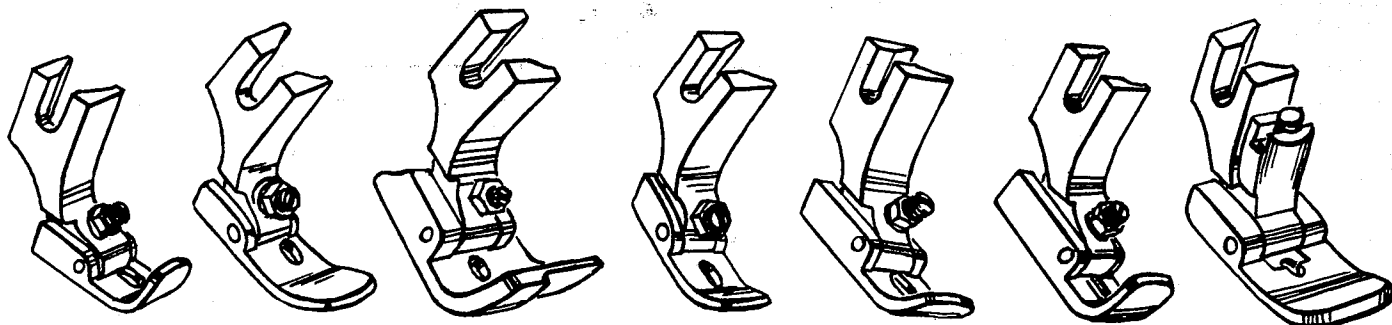

L943 L293 61420 CM 61420 BR 61420 BT 61420 AS L158

PRESSER FEET

<u>Part No.</u>	<u>Description</u>
L86 A	For welt seaming pants one operation, split shank for No. 23133 F welt guide; feed dog No. 61305 C, throat plate No. 61324 C-093 (welt guide screw No. 604)
L158	For miscellaneous seaming, chaining section behind needle; feed dog No. 61305 A, throat plate No. 61324 A-093 (bottom No. 61330 W, yielding section No. 61330 V, spring No. 1230 B)
L293	For miscellaneous house dress operations; feed dog No. 61305, throat plate No. 61324-063 (shank No. 61330 AH, bottom No. 61330 Y, adjusting screw No. 22840 A, nut No. 51430 F)
L412	For making pants flies with folder No. L464; feed dog No. 61305 A, throat plate No. 61324 A-093 (shank No. 61330 AC, spring No. 51930)
L440	For binding operations on jackets and work shirts; feed dog No. L438, throat plate No. L437
L498 A	For hemming work and dress shirts, use plate hemmer; feed dog No. 61205 A, throat plate No. 61224 C-063 (shank No. 61230 X, bottom No. 61330 AR, spring No. 51930, hinge pin No. 61330 B-35)
L525	For hemming cuffs and collar bands, use hemmer folder; feed dog No. 61205 A, throat plate No. 61224 C-073 (shank No. 61330 AC, hinge pin No. 61330 B-29)
L943	For miscellaneous seaming on plastics; feed dog No. 61305 U, throat plate No. 61324 U-063 (shank No. 61330 AH, adjusting screw No. 22840 A, nut No. 51430 F, hinge pin No. 61330 B-29)
61220	For pants fly operations, using folder No. L186; feed dog No. 61305 Q, throat plate No. 61324 Q-073 (shank No. 61330, bottom No. 61330 Y, hinge pin No. 61330 B-31)
61220 K	For attaching sleeve facings to shirts; feed dog No. 61405 K, throat plate No. 61424 K-063 (shank No. 61330 AC, bottom No. 61330 AD, spring No. 51930, hinge pin No. 61330 B-29)
61220 Q	For hemming pants flies; feed dog No. 61205 C, throat plate No. 61224 C-063 (shank No. 61330 AC, bottom No. 61330 AE, spring No. 51930, hinge pin No. 61330 B-29)
61220 S	For stitching shirt pockets, right side, yielding; feed dog No. 61205 A, throat plate No. 61224 C-063 (shank No. 61230 S, bottom No. 61230 L, right yielding section No. 61230 M, spring No. 51930, hinge pin No. 61330 B-31)
61220 W	For edge stitching pockets, left side yielding; feed dog No. L579, throat plate No. L580 (shank No. 61230 X, bottom No. 61230 V, left yielding section No. 61230 W, spring No. 51930, hinge pin No. 61330 B-35)
61320 AG	For edge stitching shirt pockets, right side yielding; feed dog No. 61205 C, throat plate No. 61224 C-063 (shank No. 61330 AK, bottom No. 61330 AJ, right yielding section No. 61330 AL, spring No. 51930, hinge pin No. 61330 B-35)
61320 AH	For edge stitching shirt pockets, left side yielding; feed dog No. 61205 C, throat plate No. 61224 C-063 (shank No. 61330 AP, bottom No. 61330 AM, left yielding section No. 61330 AN, spring No. 51930, hinge pin No. 61330 B-31)
61320 AJ	For edge stitching shirt pockets, left side yielding; feed dog No. 61205 C, throat plate No. 61224 C-063 (shank No. 61230 X, bottom No. 61330 AR, left yielding section No. 61330 AS, spring No. 51930, hinge pin No. 61330 B-35)
61420	For stitching down waistbands on pants, both sides yielding; feed dog No. 61305 A, throat plate No. 61324 A-093
61420 A	For second operation attaching collars, right side yielding; feed dog No. 61205 A, throat plate No. 61224 C-063
61420 B	For second operation attaching collars, left side yielding; feed dog No. 61205 A, throat plate No. 61224 C-063
61420 AN	For setting shirt pockets, 1/32 inch margin; feed dog No. 61205 C, throat plate No. 61224 C-063 (spring No. 51930, hinge screw No. 22799 H)
61420 AP	For one operation pants fly, for medium weight materials; folder No. L495, feed dog No. 61305 A, throat plate No. 61324 A-093 (shank No. 61330, hinge pin No. 61330 B-29)
61420 AR	For miscellaneous edge stitching, 1/32 inch margin; edge guide No. 61303, feed dog No. 61205 E, throat plate No. 61224 E-063 (hinge pin No. 61330 B-29)
61420 AS	For miscellaneous operations on plastics; feed dog No. 61305 U, throat plate No. 61324 U-063 (shank No. 61330 AH, adjusting screw No. 22840 A, nut No. 51430 F, hinge pin No. 61330 B-29)
61420 AT	For miscellaneous operations on silk, rayon, and light weight materials; feed dog No. 61205 C, throat plate No. 61224 C-063
61420 BR	For miscellaneous seaming on plastics; feed dog No. 61305 U, throat plate No. 61324 U-063 (shank No. 61330 AH, bottom No. 61430 T, adjusting screw No. 22840 A, nut No. 51430 F, hinge pin No. 61330 B-31)
61420 BT	For miscellaneous seaming on plastics; feed dog No. 61305 U, throat plate No. 61324 U-063 (shank No. 61330 AH, bottom No. 61430 Y, adjusting screw No. 22840 A, nut No. 51430 F, hinge pin No. 61330 B-31)
61420 CM	For sleeve facing operation; feed dog No. 61405 AN, throat plate Nos. 61424 AM-053 or 61424 AM-063 (shank No. 61330 AH, adjusting screw 22840 A, nut No. 51430 F, hinge pin No. 61330 B-35)

NOTE: See page 78 for sewing margins of presser feet.

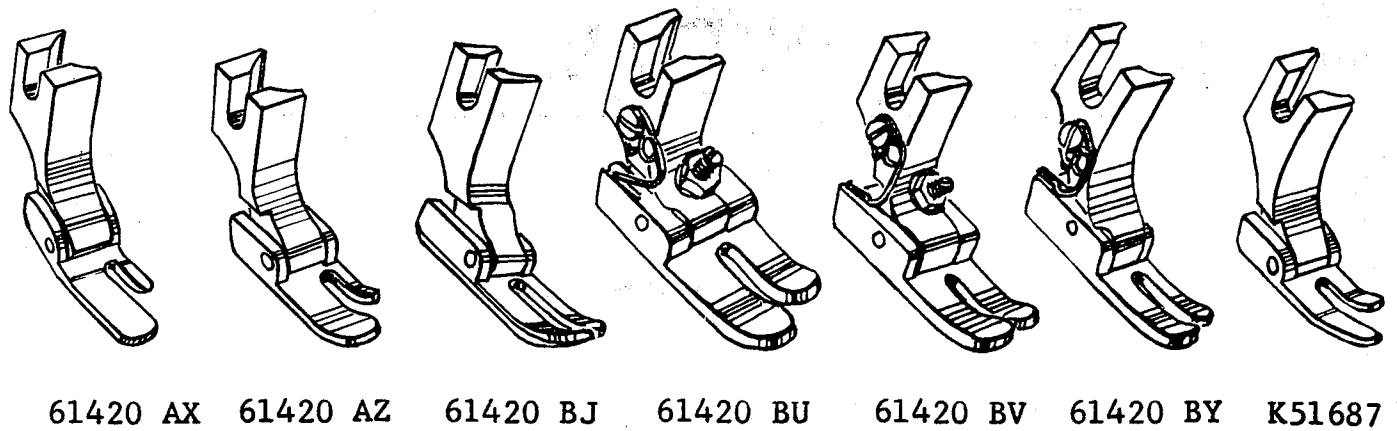
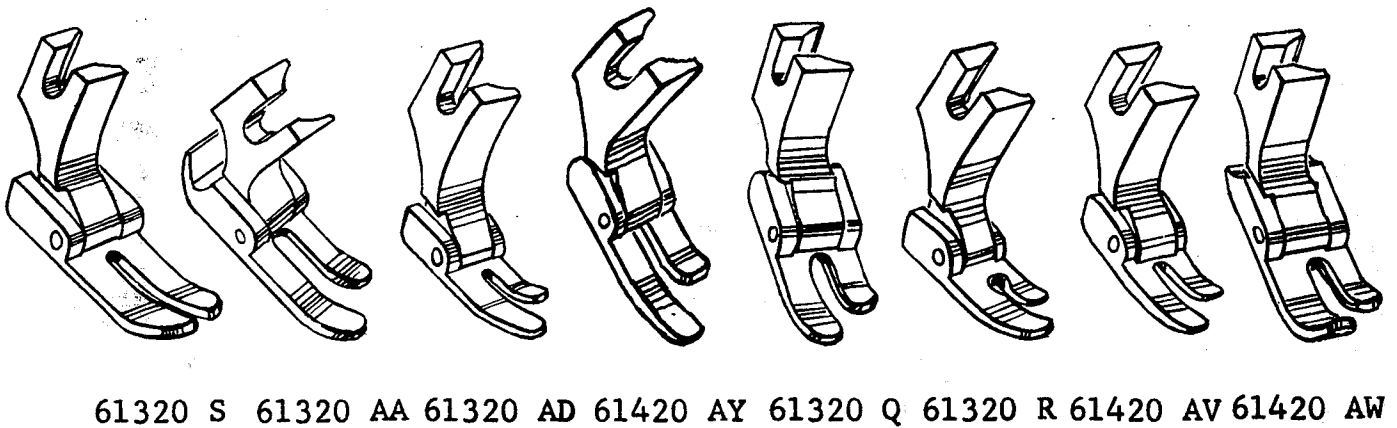
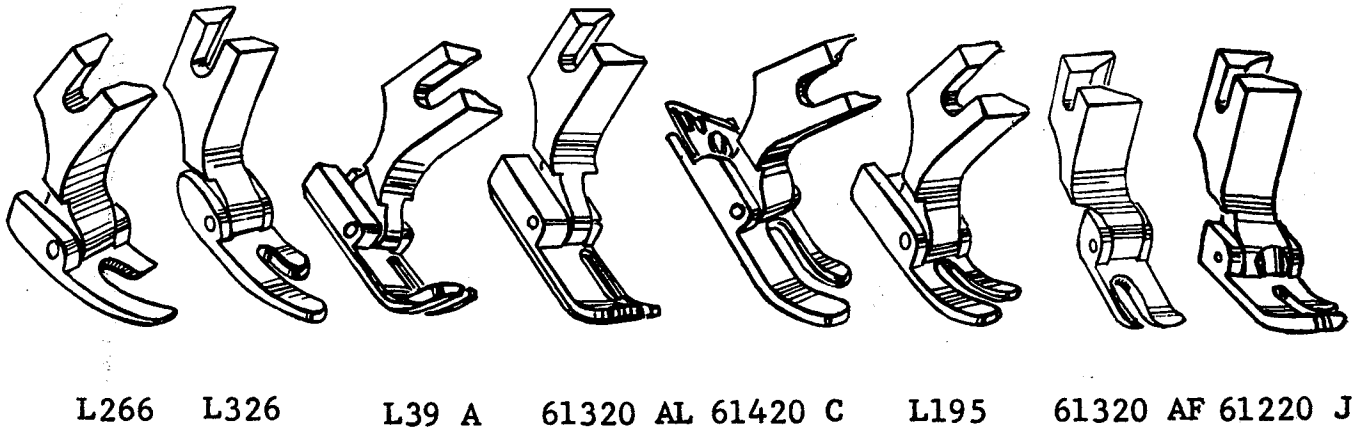
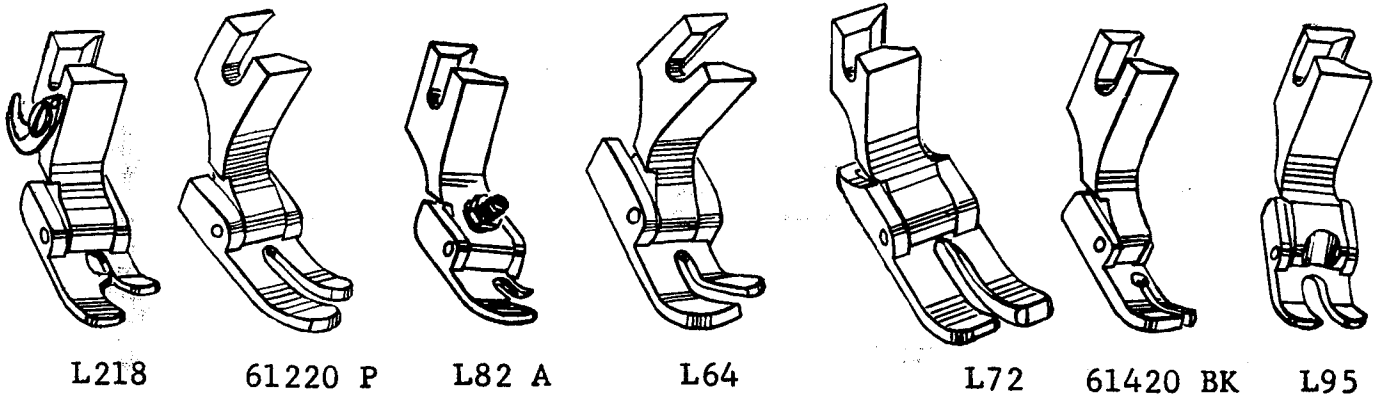

PRESSER FEET

<u>Part No.</u>	<u>Description</u>
L39 A	For seaming on two or more ply materials; feed dog No. 61305 T, throat plate No. 61324 R-073 (spring No. 51930, hinge pin No. 61330 B-29)
L64	For hemming overall suspender straps; feed dog No. 61305 M, throat plate No. 61324 L-093 (shank No. 61330)
L72	For edge stitching, right side of bottom 1/32 inch lower, 1/16 inch to right of needle, feed dog No. 61305 C, throat plate No. 61324 C-063 (shank No. 61330, hinge pin No. 61330 B-35)
L82 A	For binding plastics; feed dog No. 61305 U, throat plate No. 61324 U-063 (shank No. 61330 AH, bottom No. 61330 Z, adjusting screw No. 22840 A, nut No. 51430 F, hinge pin No. 61330 B-29)
L95	For miscellaneous seaming operations; feed dog No. 61205 A, throat plate No. 61224 C-063 (shank No. 61330, hinge pin No. 61330 B-31)
L195	For miscellaneous shirt operations; feed dog No. 61205 A, throat plate No. 61224 C-063 (shank No. 61330 AC, hinge pin No. 61330 B-29)
L218	For edge stitching dress shirt collars; feed dog No. 61205 A, throat plate No. 61224 C-063 (shank No. 61330, bottom No. 61230 F, pin No. 1741 A, knife No. 1741 B, screw No. 187 A, hinge pin No. 61330 B-35)
L266	For miscellaneous operations on suit pants and coats; feed dog No. 61305 E, throat plate No. 61324 E-073 (shank No. 61330 AC, hinge pin No. 61330 B-35)
L326	For miscellaneous seaming, 5/16 inch feed surface in back of needle; feed dog No. 61305 B, throat plate No. 61324 B-093 (shank No. 61330 AC, spring No. 61230 AK, hinge pin No. 61330 B-31)
K51687	For miscellaneous seaming on light weight materials; feed dog No. 61205 C, throat plate No. 61224 C-063 (shank No. 61330 AC, hinge pin No. 61330 B-29)
61220 J	For seaming light and medium weight woven materials; has spring for raising toe; feed dog No. 61205 C, throat plate No. 61224 C-063 (shank No. 61330, bottom No. 61330 Z, spring No. 61230 AK, hinge pin No. 61330 B-31)
61220 P	For miscellaneous operations on medium weight materials; has spring for raising toe; feed dog No. 61305 A, throat plate No. 61324 A-093 (shank No. 61330, bottom No. 61330 AG, spring No. 51930, hinge pin No. 61330 B-35)
61320 Q	For tacking flies to overalls; feed dog No. 61305 F, throat plate No. 61324 D-063 (shank No. 61330, bottom No. 61330 R, hinge pin No. 61330 B-35)
61320 R	For plain seaming operations on work shirts; feed dog No. 61305 N, throat plate No. 61324 N-073 (shank No. 61330 AC, bottom No. 61330 AF, hinge pin No. 61330 B-31)
61320 S	For miscellaneous operations on heavy coats, trousers and similar operations; feed dog No. 61305 K, throat plate No. 61324 J-093 (shank No. 61330, bottom No. 61330 T, hinge pin No. 61330 B-29)
61320 AA	For miscellaneous operations on denim, canvas and other heavy materials; feed dog No. 61305 C, throat plate No. 61324 C-093 (shank No. 61330 AC, bottom No. 61330 AB, spring No. 51930, hinge pin No. 61330 B-35)
61320 AD	For miscellaneous seaming operations on rayon and other light materials; feed dog No. 61205 C, throat plate No. 61224 C-063 (shank No. 61330 AC, bottom No. 61330 AU, spring No. 61230 AK, hinge pin No. 61330 B-31)
61320 AF	For sewing zipper tabs to various type garments, feed dog No. 61205 A, throat plate No. 61224 C-063
61320 AL	For miscellaneous seaming on heavy materials; feed dog Nos. 61205 A, 61305 T, throat plate Nos. 61224 C-083, 61324 R-093 (shank No. 61330 AV, bottom No. 61330 AW, hinge pin No. 61330 B-29)
61420 C	For sewing on pocket facing to trousers and chaining between pockets, foot equipped with chain cutting knife, feed dog No. 61405 C, throat plate No. 61424 C-093 (shank No. 61330, bottom No. 61430 C, knife No. 61430 A, knife guard No. 61430 B, spring No. 51930, screw No. 73 A, hinge pin No. 61330 B-35)
61420 AV	For miscellaneous seaming on dresses and shirts made of light weight woven materials; feed dog No. 61205 E, throat plate No. 61224 E-063 (spring No. 51930, hinge pin No. 61330 B-29)
61420 AW	For miscellaneous seaming on dress pants and suits made of cotton and wool materials; feed dog No. 61305 C, throat plate No. 61324 C-093 (shank No. 61330, hinge pin No. 61330 B-35)
61420 AX	For sewing zipper tabs to pants flies; feed dog No. 61205 E, throat plate No. 61224 E-063 (hinge pin No. 61330 B-29)
61420 AY	For miscellaneous seaming on work and dress pants; feed dog No. 61205 A, throat plate No. 61224 C-063 (shank No. 61330)
61420 AZ	For sewing zipper tabs, feed dog No. 61205 E, throat plate No. 61224 E-063 (shank No. 61330 AV, hinge pin No. 61330 B-29)
61420 BJ	For collar operation on dress shirts; feed dog No. 61405 S, throat plate No. 61424 S-063 (shank No. 61330)
61420 BK	For attaching waistbands, hemming trousers and sewing zippers to rayon material; feed dog No. 61205 C, throat plate No. 61224 C-063 (shank No. 61330 AV, hinge pin No. 61330 B-29)
61420 BU	For setting front pockets on wash and wear pants; feed dog No. 61405 AA, throat plate No. 61424 AA-063 (shank No. 61430 AA, bottom No. 61430 AB, spring No. 61430 BB, adjusting screw No. 22565 E, screw No. 226, nut No. 51430 F)
61420 BV	For edge stitching operations on wash and wear shirts and pants; feed dog No. 61405 AB, throat plate No. 61424 AB-053 (shank No. 61430 AA, bottom No. 61430 AC, spring No. 61430 BB, adjusting screw No. 22565 E, screw No. 226, nut No. 51430 F)
61420 BY	For miscellaneous operations on wash and wear materials; feed dog No. 61405 AE, throat plate No. 61424 AE-053 (shank No. 61430 AT, bottom No. 61430 AS, spring No. 61430 BB, screw No. 226)

NOTE: See page 78 for sewing margins of presser feet.

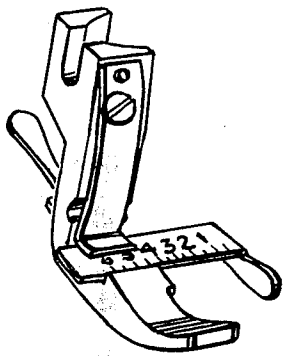

61320 N

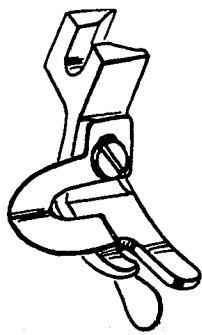

61420 K

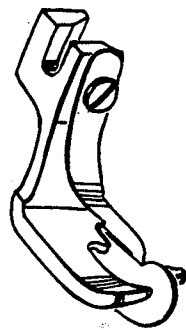

61320 E

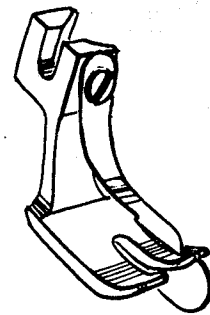

61320 F

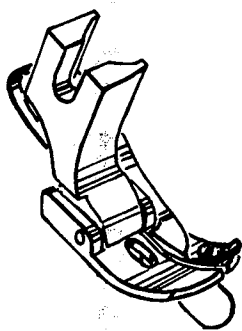

L653

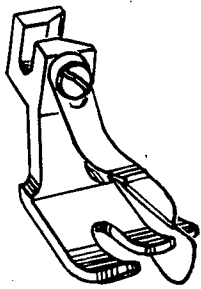

61320 AE

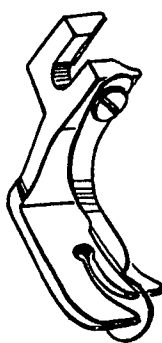

61320 V

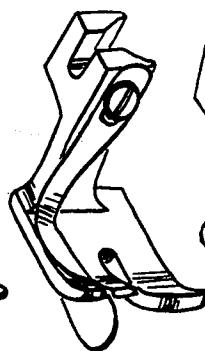

L336

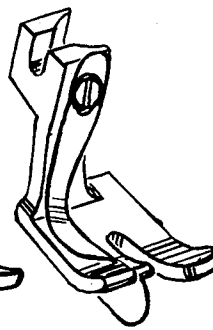

L637



61420 L

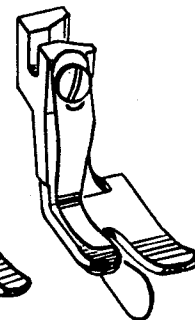

L415



61220 AC



61320 U



L17

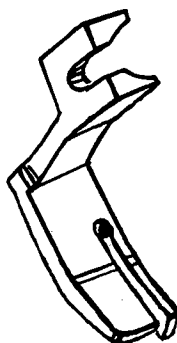

61420 AJ

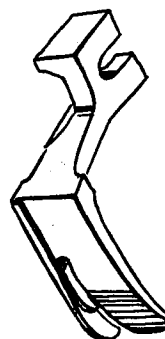

61220 N

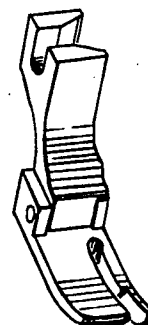

61420 AF

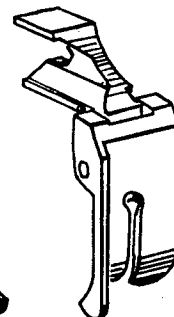

61420 AD

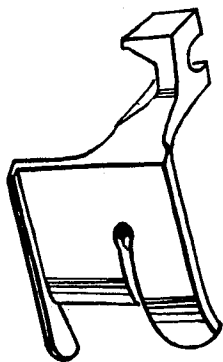

61420 AM

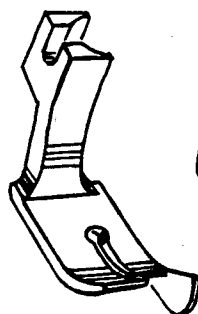

61420 E

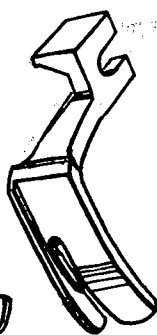

61320 AB

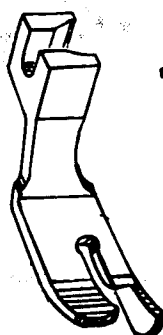

61420 BH

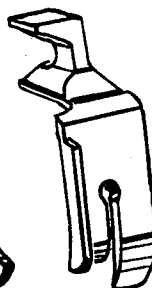

61420 AH

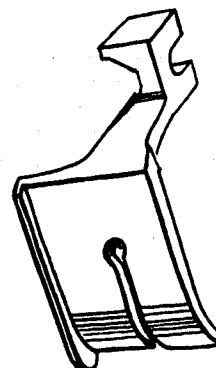

61420 AG

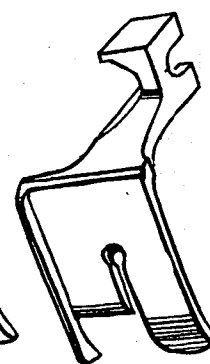

61420 AK

PRESSER FEET

<u>Part No.</u>	<u>Description</u>
L17	For edge stitching collars, left side of bottom .030 inch lower; feed dog No. 61205 A, throat plate No. 61224 C-073
L336	For edge stitching, spring guide located 1/4 inch to left of needle; feed dog No. 61305 A, throat plate No. 61324 A-093 (spring guide No. L683, screw No. 187 A)
L415	For edge stitching on heavy materials, 3/32 inch margin to left of needle; feed dog No. 61205 D, throat plate No. 61224 F-083 (spring guide No. L683, screw No. 187 A)
L637	For edge stitching, 3/16 inch margin to left of needle; feed dog No. 61305 A, throat plate No. 61324 A-093 (spring guide No. L683, screw No. 187 A)
L653	For hemming, with plate hemmer, 3/32 inch margin to right of needle; feed dog No. 61405 L, throat plate No. 61424 L-063; (spring guide L122 A, spring No. 51930, screw No. 73 A, hinge pin No. 61330 B-29)
61220 N	For attaching labels, guide 1/16 inch to right of needle; feed dog No. 61205 A, throat plate No. 61224 C-063
61220 AC	For edge stitching collar bands, guide 3/64 inch to right of needle; feed dog No. 61205 A, throat plate No. 61224 C-063 (spring guide No. 61230 U, screw No. 187 A)
61320 E	For edge stitching overall pockets, guide 3/32 inch to right of needle; feed dog No. 61305 A, throat plate No. 61324 A-093 (spring guide No. 61330 E, screw No. 187 A)
61320 F	For edge stitching overall pockets, guide 3/16 inch to right of needle; feed dog No. 61305 A, throat plate No. 61324 A-093 (spring guide No. 61330 F, screw No. 187 A)
61320 N	For edge stitching adjustable guide; feed dog No. 61205 B, throat plate No. 61224 B-063 (main section No. 61330 M, spring No. 61330 N, spring release lever No. 61330 P, guide No. 61330 Q, screw No. 22547 A)
61320 U	For edge stitching overalls, guide 1/16 inch to right of needle; feed dog No. 61305 A, throat plate No. 61324 A-093 (spring guide No. 61230 U, screw No. 187 A)
61320 V	For edge stitching overall pockets, guide 1/8 inch to right of needle; feed dog No. 61305 A, throat plate No. 61324 A-093 (spring guide No. 61330 E, screw No. 187 A)
61320 AB	For edge stitching on pants flies, guide 1/16 inch to right of needle; feed dog No. 61205 A, throat plate No. 61224 C-073
61320 AE	For miscellaneous edge stitching, spring guide located 1/4 inch to right of needle, feed dog No. 61305 A, throat plate No. 61324 A-093 (spring guide No. 61330 F, screw No. 187 A)
61420 E	For edge stitching, guide 1/4 inch to right of needle; feed dog No. 61305 A, throat plate No. 61324 A-093
61420 K	For setting pockets, spring guide 1/16 inch to left of needle; feed dog No. 61305 A, throat plate No. 61324 A-093 (spring guide No. 61430 M, screw No. 22561)
61420 L	For setting pockets to work shirts, spring guide 1/16 inch to left of needle; feed dog No. 61205 C, throat plate No. 61224 C-083 (spring guide No. 61430 N, screw No. 187 A)
61420 AD	For edge stitching coats and jackets, 3/16 inch margin to right of needle; feed dog No. 61205 A, throat plate No. 61224 C-083 (shank No. 61330, hinge pin No. 61330 B-39)
61420 AF	For edge stitching shirts and dresses, 1/32 inch margin to right of needle; feed dog No. 61405 Z, throat plate No. 61224 B-063 (hinge pin No. 61330 B-29)
61420 AG	For edge stitching work jackets, 3/8 inch margin to right of needle; feed dog No. 61205 D, throat plate No. 61224 F-063
61420 AH	For top stitching shirt and pajama collars, 3/16 inch margin to right of needle; feed dog No. 61405 J, throat plate No. 61424 J-063
61420 AJ	For edge stitching pockets on dresses and shirts, 1/32 inch margin to right of needle; feed dog No. 61405 Z, throat plate No. 61224 B-063
61420 AK	For edge stitching on light to heavy materials, 3/8 inch margin to right of needle; feed dog No. 61305 A, throat plate No. 61324 A-093
61420 AM	For edge stitching, 1/2 inch margin to right of needle; feed dog 61405 AN, throat plate No. 61424 AM-053 or 61424 AM-063
61420 BH	For edge stitching, 1/8 inch margin to right of needle; feed dog No. 61305 A, throat plate No. 61324 A-093

NOTE: See page 78 for sewing margins of presser feet.

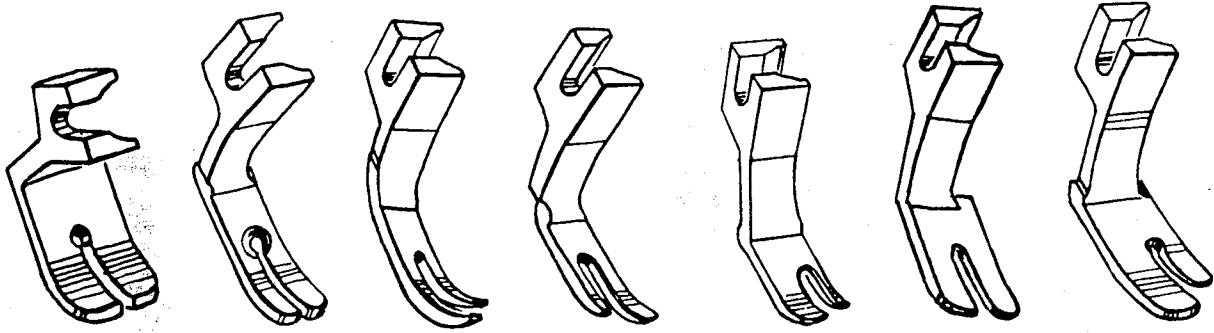

K51683 61420 P 61320 AC 61320 M 61420 R 61220 G 61320 P

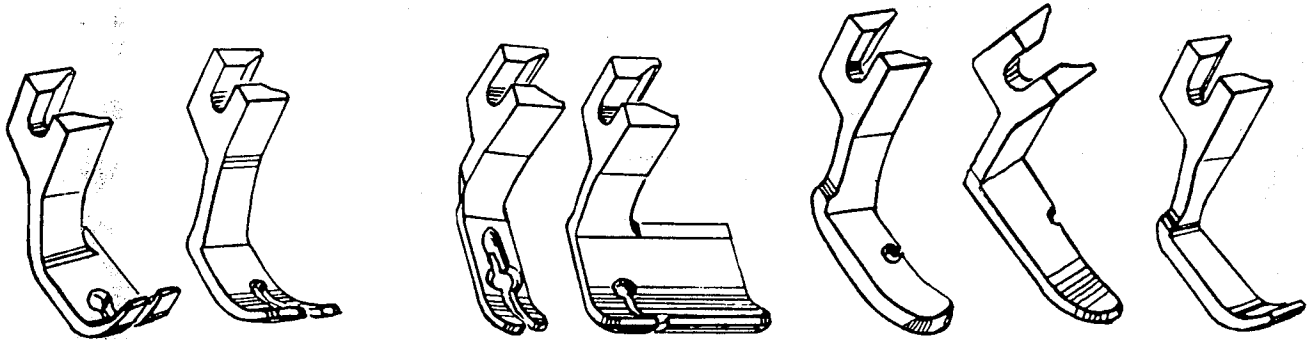

61420 F 61320 X 61420 CL 61420 S 61220 AB 61220 R 61420 J

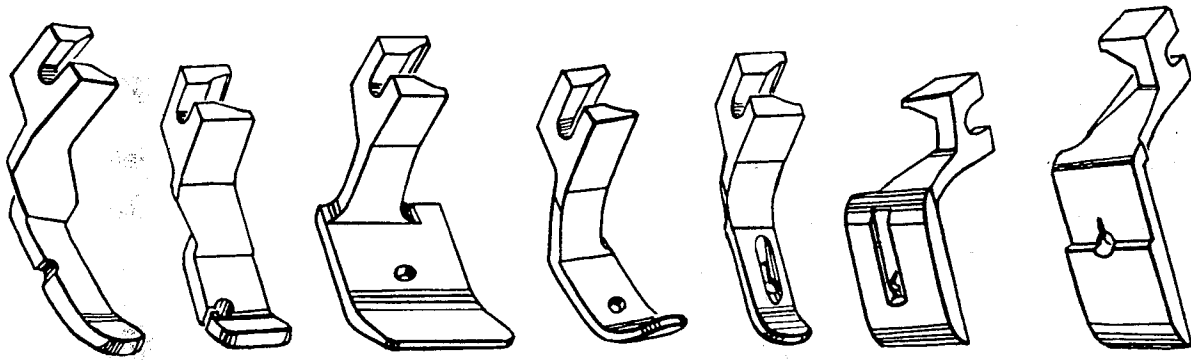

61220 V 61420 V 61420 U 61220 T 61420 BB L217 61320 K

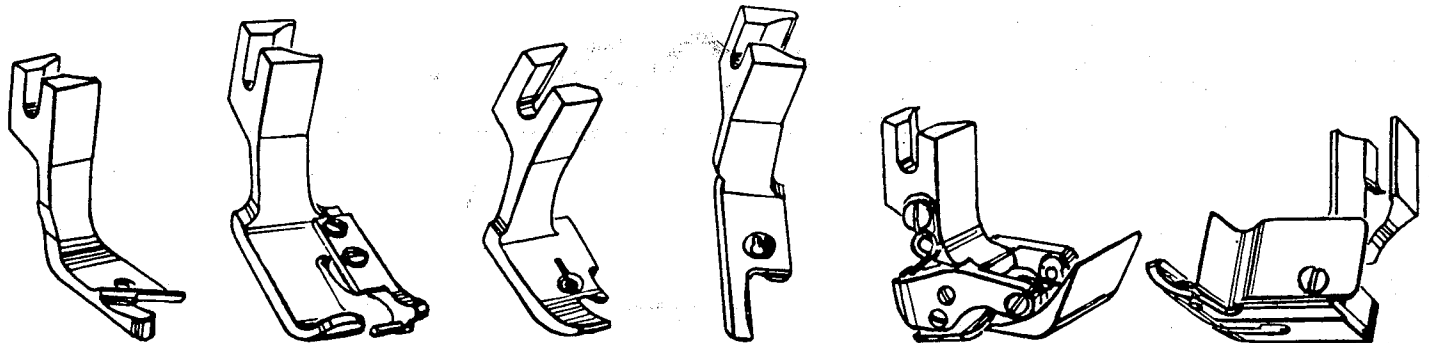

61420 BG L768 L205 L368 L556 405-571

PRESSER FEET

<u>Part No.</u>	<u>Description</u>
L205	For miscellaneous hemming, used with 3/16 inch hemmer; feed dog No. 61205 A, throat plate No. 61224 C-063
L217	For braiding sport shirts and similar garments, 7/64 inch braiding groove in center of needle; feed dog No. 61205 A, throat plate No. 61224 C-083
L368	For hemming handkerchiefs, feed dog No. L369, throat plate No. L391
405-571	For miscellaneous seaming; feed dog No. 61305 C, throat plate No. 61324 C-093 (shank No. 61330 AC, spring No. 51930, chip guard screw No. 22798, hinge pin No. 61330 B-29)
L556	For hemming heavy shirts and jackets, tractor type; feed dog No. 61305 A, throat plate No. 61324 A-093 (rear section No. 35730 C, yoke No. 35730 D, spring No. L314 A, yoke screw No. 22799 B, hinge screw No. 22801, spring screw No. 226)
L768	For top stitching collars, guide 3/16 inch to right of needle; feed dog No. L223, throat plate No. L222 (screw for guide No. 22738)
K51683	For attaching cuffs to shirts; feed dog No. 61305 A, throat plate No. 61324 A-093
61220 G	For hemming work shirts, used with plate hemmer; feed dog No. 61205 A, throat plate No. 61224 C-063
61220 R	For zipper tab operation; feed dog No. 61205 A, throat plate No. 61224 C-073
61220 T	For hemming towels; feed dog No. 61205 A, throat plate No. 61224 C-073
61220 V	For zipper tab operation; feed dog No. 61205 A, throat plate No. 61224 C-073
61220 AB	For edge stitching; feed dog No. 61205 A, throat plate No. 61224 C-063
61320 K	For shirring light weight house dresses; feed dog No. 61205 A, throat plate No. 61224 C-073
61320 M	For attaching zippers to light weight garments; feed dog No. 61205 A, throat plate No. 61224 C-063
61320 P	For miscellaneous seaming; feed dog No. 61305 D, throat plate No. 61324 D-073
61320 X	For top stitching waistbands to work pants; feed dog No. 61405 G, throat plate No. 61424 G-093
61320 AC	For attaching hook and eye strips to corsets; feed dog No. 61305 S, throat plate No. 61224 C-043
61420 F	For hemming work shirts, used with plate hemmer; feed dog No. 61205 A, throat plate No. 61224 C-063
61420 J	For top stitching waistbands to work pants; feed dog No. 61305 A, throat plate No. 61324 A
61420 P	For tacking pants flies; feed dog No. 61205 C, throat plate No. 61224 C-063
61420 R	For sewing zipper tabs to pants flies; feed dog No. 61205 A, throat plate No. 61224 C-083
61420 S	For attaching sleeve facings to work shirts; foot extends 3/4 inch to right of needle; feed dog No. 61405 K, throat plate No. 61424 K-063
61420 U	For pants flies, one operation; folder No. L186, feed dog No. 61205 A, throat plate No. 61224 C-083
61420 V	For sewing zipper tabs to pants flies, 1/16 inch margin to left of needle; feed dog No. 61405 R, throat plate No. 61424 R-073
61420 BB	For miscellaneous seaming and hemming silk and rayon; feed dog No. 61205 C, throat plate No. 61224 C-043
61420 BG	For hemming bed sheets; feed dog No. 61205 C, throat plate No. 61224 C-063
61420 CL	For zipper tab operation; feed dog No. 61205 A, throat plate No. 61224 C-063

NOTE: See page 78 for sewing margins of presser feet.

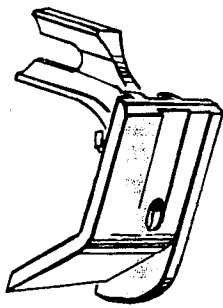

L566

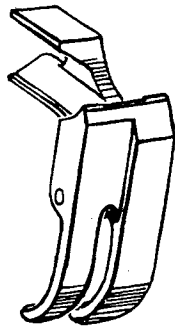

61320 L

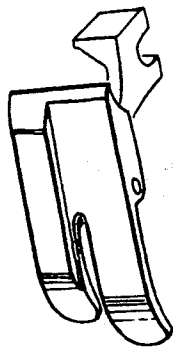

61420 AE

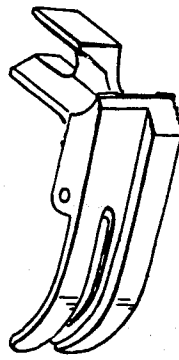

L313

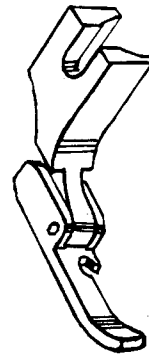

61320 AM

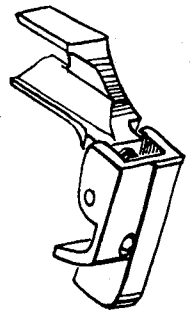

61420 BD

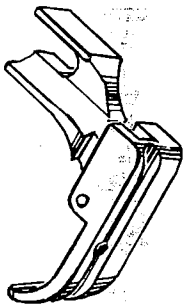

L17 A

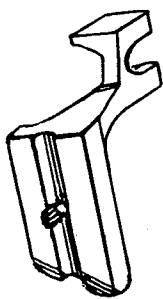

61420 N

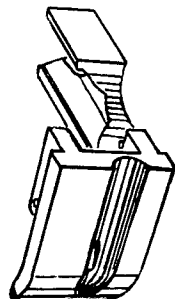

61420 M

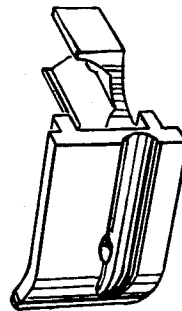

61420 BC

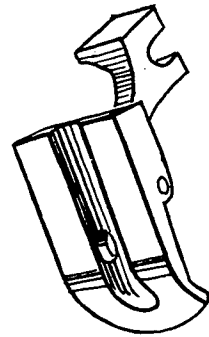

L220

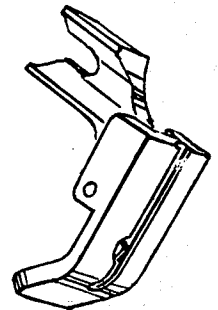

L380

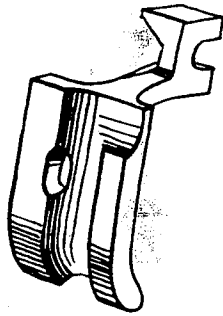

K51645

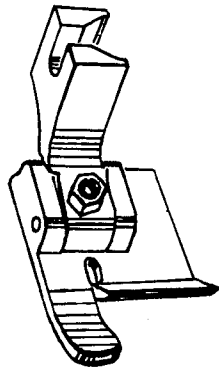

61420 H

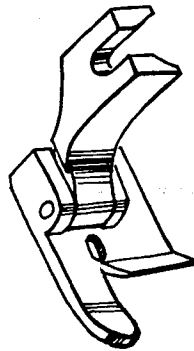

61420 AU

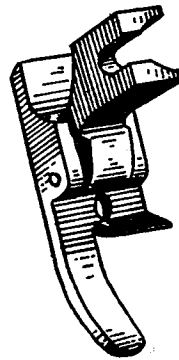

61320 C

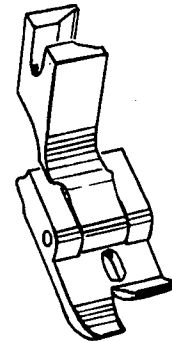

61420 BN

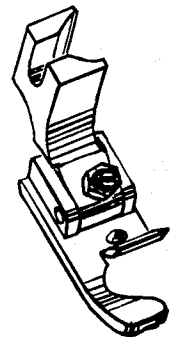

61420 T

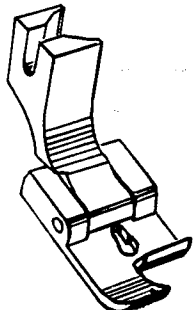

L505

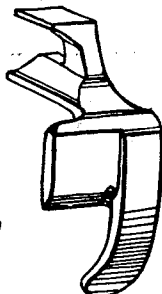

L193

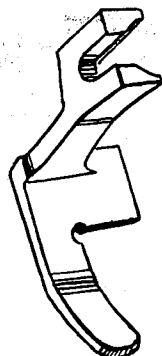

L290

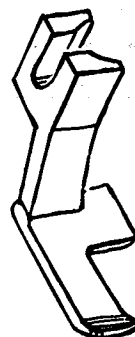

61320

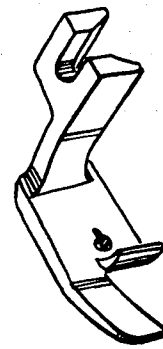

61420 BE

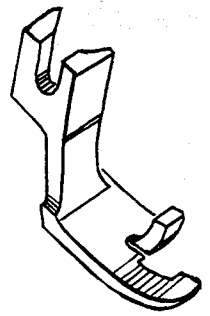

61220 H

PRESSER FEET

<u>Part No.</u>	<u>Description</u>
L17 A	For piping pillow slips, foot has 1/16 inch groove to left of needle; feed dog No. 61405 J, throat plate No. 61424 J-063 (hinge pin No. 61330 B-29)
L193	For edge stitching coats, right toe cut off at needle; feed dog No. 61305 B, throat plate No. 61324 B-073
L220	For cording couch covers, 3/16 inch cord groove 1/32 inch to left of needle; feed dog No. 61305 A, throat plate No. 61324 A-093 (shank No. 61330)
L290	For edge stitching coats and similar garments; feed dog No. 61305 G, throat plate No. 61324 F-093
L313	For edge stitching, left side of bottom 1/16 inch lower, 1/16 inch to left of needle; feed dog No. 61305 A, throat plate No. 61324 A-093 (shank No. 61330, hinge pin No. 61330 B-35)
L380	For cording and piping pajama coats; feed dog No. 61305 B, throat plate No. 61324 B-063 (shank No. 61330)
L505	For miscellaneous hemming operations, guide on left of needle; feed dog No. 61305 C, throat plate No. 61324 C-093 (shank No. 61330, hinge pin No. 61330 B-39)
L566	For sleeve facing, left edge guide 5/16 inch from center of needle; feed dog No. 61405 K, throat plate No. 61424 K-063 (shank No. 61330 AH, adjusting screw No. 22840 A, nut No. 51430 F, hinge pin No. 61330 B-35)
K51645	For cording upholstery, 9/32 inch cord groove, 1/32 inch to left of needle; feed dog No. 61305 K, throat plate No. 61324 J-093
61220 H	For miscellaneous binding operations on melton jackets; feed dog No. 61305 H, throat plate No. 61224 D-073
61320	For edge stitching on men's suits, coats; feed dog No. 61305 B, throat plate No. 61324 B-093
61320 C	For hemming high back overall suspenders; feed dog No. 61305 C, throat plate No. 61324 C-093 (shank No. 61330, bottom No. 61330 C, hinge pin No. 61330 B-39)
61320 L	For hemming overall suspenders, guide 1/16 inch to left of needle; feed dog No. 61305 A, throat plate No. 61324 A-093 (shank No. 61330, bottom No. 61330 L, hinge pin No. 61330 B-35)
61320 AM	For attaching collar bands to dress shirts; feed dog No. 61205 C, throat plate No. 61224 C-063 (shank No. 61330 AV, bottom No. 61330 AX, hinge pin No. 61330 B-29)
61420 H	For attaching sleeve facings to shirts; feed dog No. 61405 K, throat plate No. 61424 K-063 (shank No. 61330 AH, adjusting screw No. 22840 A, nut No. 51430 F, hinge pin No. 61330 B-35)
61420 M	For piping upholstery, furniture and automobile cushions, 5/32 inch piping; feed dog No. L438, throat plate No. L437 (hinge screw No. 22799 B)
61420 N	For piping pajama fronts and collars, 3/32 inch prepared piping; feed dog No. 61205 A, throat plate No. 61224 C-063
61420 T	For binding; feed dog No. 61305 B, throat plate No. 61324 B-063 (shank No. 61330 AH, adjusting screw No. 22840 A, nut No. 51430 F, hinge pin No. 61330 B-35)
61420 AE	For edge stitching overall suspenders, 1/16 inch margin to right of needle; feed dog No. 61305 C, throat plate No. 61324 C-093 (shank No. 61330, hinge pin No. 61330 B-39)
61420 AU	For hemming pajama coats, 5/8 inch hem, 9/16 inch margin to right of needle; feed dog No. 61405 K, throat plate No. 61424 K (shank No. 61330, hinge pin No. 61330 B-35)
61420 BC	For cording and upholstery, 3/16 inch cord groove to left of needle; feed dog No. L438, throat plate No. L437 (hinge screw No. 22799 B)
61420 BD	For yoking shirts, guide extends 1/32 inch to left of needle; feed dog No. 61405 M, throat plate No. 61424 M-063 (shank No. 61330 AC, bottom No. 61430 S, hinge pin No. 61330 B-29)
61420 BE	For miscellaneous binding on rayon and similar materials; feed dog No. 61405 L, throat plate No. 61424 L-063
61420 BN	For hemming work shirts, 1/16 inch margin to left of needle, use plate hemmer; feed dog No. 61205 CA, throat plate No. 61224 C-063 (shank No. 61330, hinge pin No. 61330 B-39)

NOTE: See page 78 for sewing margins of presser feet.

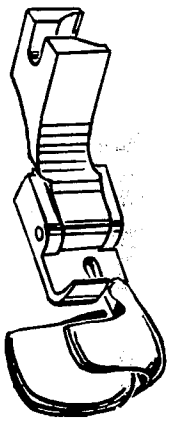

L408

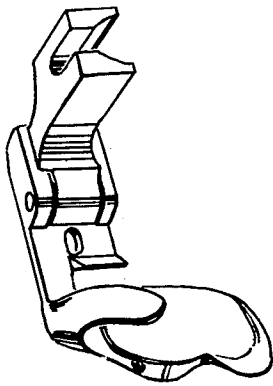

L529

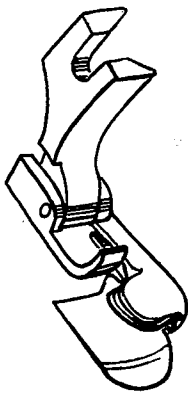

61420 Z

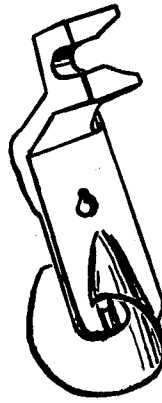

61420 X

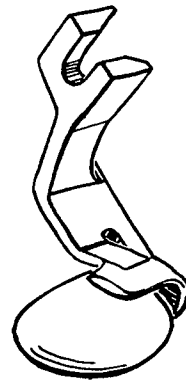

61420 W

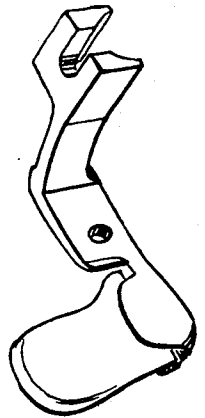

L139

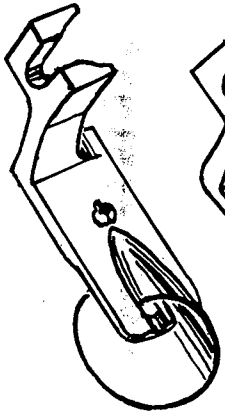

61220 M

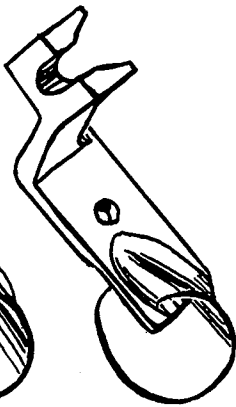

61420 Y

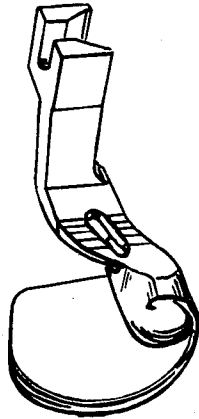

L473

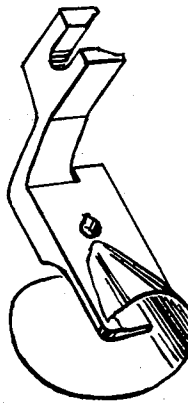

L775

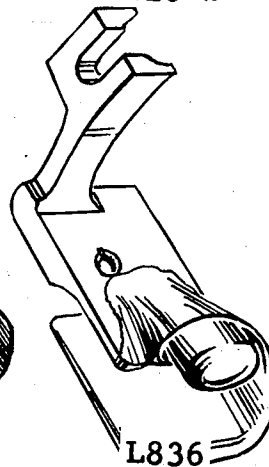

L836

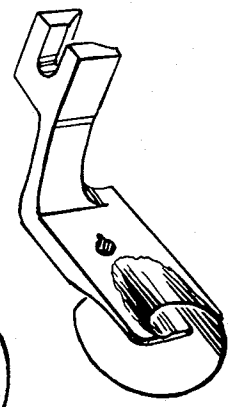

L748

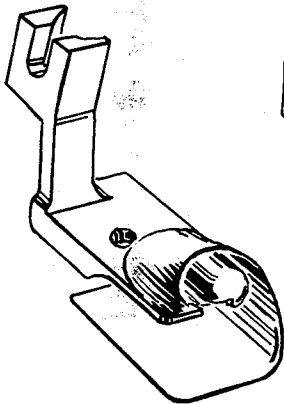

L582

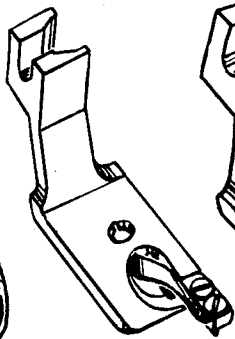

L292

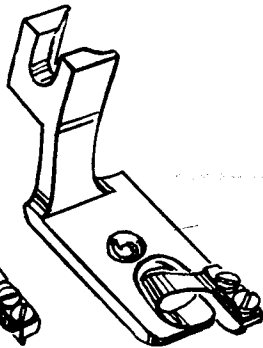

L868

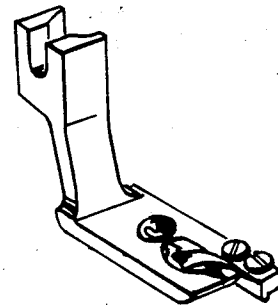

L727

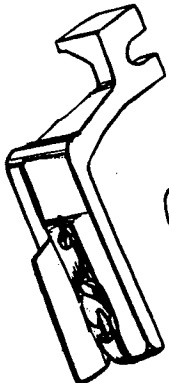

L30

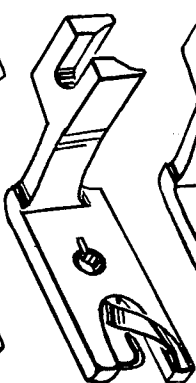

L756

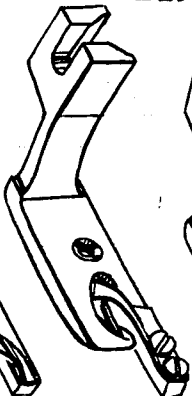

61220 AA

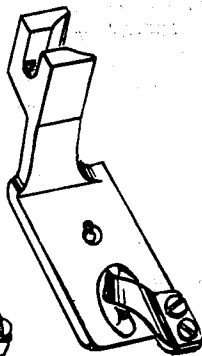

61420 AC



61220 B

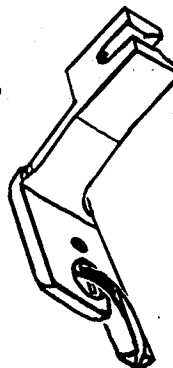

61220 C

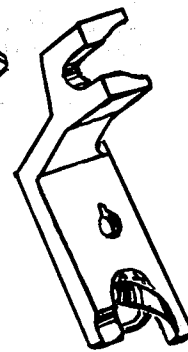

61220 D

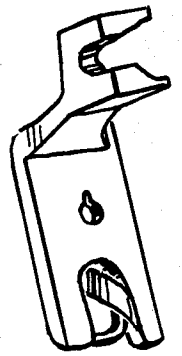

61220 L

PRESSER FEET

<u>Part No.</u>	<u>Description</u>
L30	For hemming, 1/8 inch hem, has guide to fit in throat plate; feed dog No. L29, throat plate No. L28 (scroll No. L774)
L139	For miscellaneous hemming, material enters from left, 3/16 inch turned down hem; feed dog No. 61205 C, throat plate No. 61224 C-063
L292	For hemming shirts, 3/16 inch hem; feed dog No. 61405 Z, throat plate No. 61224 B-063 (scroll pin No. 61230 C, screw No. 22738)
L408	For attaching yokes, 5/16 inch turned down fold; feed dog No. 61205 A, throat plate No. 61224 C-063 (shank No. 61330; hinge pin No. 61330 B-29)
L473	For miscellaneous hemming, 5/32 inch turned up hem; feed dog No. 61205 A, throat plate No. 61224 C-063
L529	For attaching yokes, 3/16 inch turned down fold; feed dog No. 61205 A, throat plate No. 61224 C-063 (hinge pin No. 61330 B-35)
L582	For hemming dresses, material enters from left, 3/8 inch turned up hem; feed dog No. 61205 C, throat plate No. 61224 C-063
L727	For hemming shirts, 3/32 inch hem; feed dog No. 61405 Z, throat plate No. 61224 B-063 (scroll No. 61230 A-1/8, scroll pin No. 61230 C, screw No. 22738)
L748	For hemming dresses, material enters from left, 1/4 inch turned up hem; feed dog No. 61205 A, throat plate No. 61224 C-063
L756	For hemming shirts, 7/32 inch hem; feed dog No. 61205 C, throat plate No. 61224 C-063 (scroll No. 61230-5/32)
L775	For miscellaneous hemming, material enters from left, 1/4 inch turned up hem; feed dog No. 61205 D, throat plate No. 61224 F-063
L836	For hemming dresses, material enters from left, 1/2 inch turned up hem; feed dog No. 61205 A, throat plate No. 61224 C-063
L868	For hemming shirts, 1/4 inch hem; feed dog No. 61205 C, throat plate No. 61224 C-063 (scroll No. L158 A, scroll pin No. 61230 C, screw No. 22738)
61220 B-1/8	For hemming shirts, 1/8 inch hem; feed dog No. 61205 B, throat plate No. 61224 B-063 (scroll No. 61230 B-1/8, pin No. 61230 C)
61220 B-5/32	For hemming shirts, 5/32 inch hem; feed dog No. 61205 B, throat plate No. 61224 B-063 (scroll No. 61230 B-1/8, pin No. 61230 C)
61220 C-1/8	For hemming shirts, 1/8 inch hem; feed dog No. 61205 C, throat plate No. 61224 C-063 (scroll No. 61230-5/32)
61220 C-5/32	For hemming shirts, 5/32 inch hem; feed dog No. 61205 C, throat plate No. 61224 C-063 (scroll No. 61230-5/32)
61220 C-3/16	For hemming shirts, 3/16 inch hem; feed dog No. 61205 C, throat plate No. 61224 C-063 (scroll No. 61230-5/32)
61220 C-1/4	For hemming shirts, 1/4 inch hem; feed dog No. 61205 A, throat plate No. 61224 C-063 (scroll No. 61230-5/32)
61220 D-1/8	For hemming shirts, 1/8 inch hem; feed dog No. 61405 Z, throat plate No. 61224 B-063 (scroll No. 61230-5/32, scroll pin No. 61230 J)
61220 L-5/32	For hemming shirts, 5/32 inch hem; feed dog No. 61205 B, throat plate No. 61224 B-063 (scroll No. 61230-5/32, scroll pin No. 61230 J)
61220 M-1/8	For hemming dresses, 1/8 inch hem; feed dog No. 61205 C, throat plate No. 61224 C-063
61220 AA-1/8	For hemming shirts, 1/8 inch hem; feed dog No. 61205 A, throat plate No. 61224 C-063 (scroll 61230 A-1/8, screw No. 22716 C)
61420 W	For setting yokes and turning down hems on dresses, shirts, and similar garments, 1/32 inch margin to right of needle; feed dog No. 61205 A, throat plate No. 61224 C-063
61420 X	For miscellaneous hemming, turned up hem, light weight materials; feed dog No. 61405 Y, throat plate No. 61424 Y-063
61420 Y	For hemming dresses, light weight materials, 1/16 inch turned up hem; feed dog No. 61205 C, throat No. 61224 C-063
61420 Z	For setting yokes on dress shirts and pajamas, 1/4 inch turned down fold; feed dog No. 61205 C, throat plate No. 61224 C-063 (shank No. 61330 AC, hinge pin No. 61330 B-29)
61420 AC	For hemming work shirts, 3/16 inch hem; feed dog No. 61205 C, throat plate No. 61224 C-063 (scroll No. 61430 P, screw No. 22738)

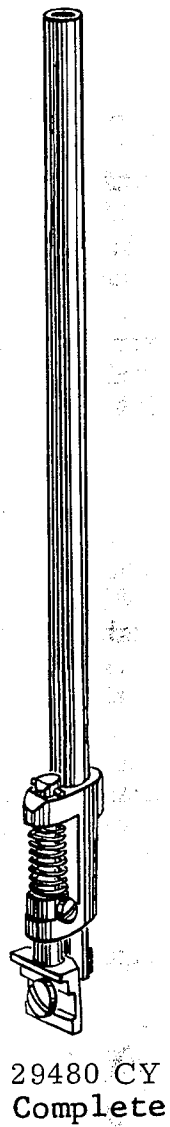

29480 CY Complete

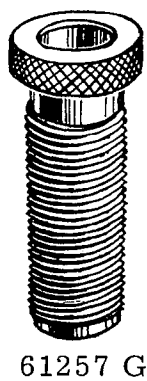

61257 G



88



91 A



22585 C



660-219 D

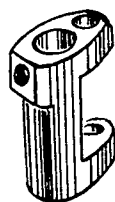

63457 F



63457 G



63457 E



63457 D



63457 C

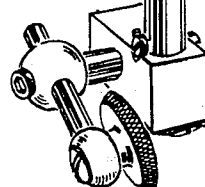

K67092 Complete



22818



22743

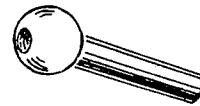

52130 F



52130 D



K67096

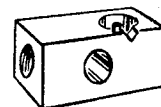

K67093



39198 D



22765



22845 B



22894 C



22894 F



63430 D



63430 C

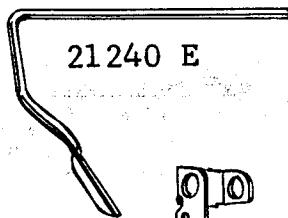

21240 E

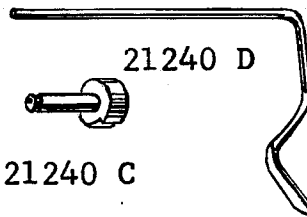

21240 D

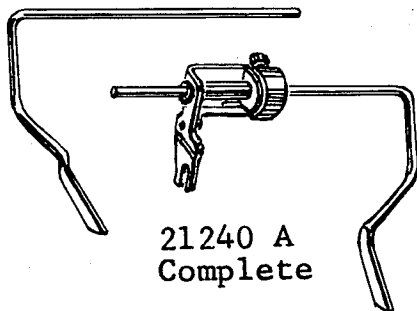

21240 A Complete



21240 B

21240 C



660-215



21240 F



T-26



91

COMPOUND PRESSER BAR ASSEMBLY, ROLLER PRESSER FOOT
ASSEMBLY, QUILTING GUIDE AND COMPONENTS

<u>Part No.</u>	<u>Description</u>
T26	Screw, for spring No. 21240 F
88	Screw, for presser bar and plunger holder No. 63457 F
91	Screw, for bushing No. 21240 C
91 A	Screw, for plunger collar No. 63457 E
660-215	Retaining Ring, for No. 21240 C
660-219 D	Roll Pin, for No. 29480 CY
21240 A	Quilting Guide, complete, with right or left guide (screw Nos. T26 and 91, retaining ring No. 660-215, bracket No. 21240 B, bushing No. 21240 C, right guide No. 21240 D, left guide No. 21240 E, spring No. 21240 F)
21240 B	Bracket, for quilting guide No. 21240 A
21240 C	Bushing, for quilting guide No. 21240 A
21240 D	Guide, right, for quilting guide No. 21240 A
21240 E	Guide, left, for quilting guide No. 21240 A
21240 F	Spring, for quilting guide No. 21240 A
22585 C	Screw, for attaching presser foot bottom on assembly No. 29480 CY
22743	Screw, for roller assembly No. 52130 D
22765	Screw, for presser bar No. K67096
22818	Screw, for roller assembly No. 52130 D
22845 B	Screw, for presser bar No. K67096
22894 C	Screw, for roller presser foot arm No. 52130 F
22894 F	Screw, for roller presser foot swing-out collar No. K67093
29480 CY	Compound Presser Bar Assembly (roll pin No. 660-219 D, presser bar No. 63457 B, presser guide plunger No. 63457 D, plunger collar No. 63457 E, presser bar and plunger holder No. 63457 F, spring No. 63457 G)
39198 D	Spring Washer, for screw No. 22765
52130 D	Roller Assembly, for roller presser foot assembly No. K67092
52130 F	Roller Presser Foot Arm, for assembly No. K67092
61257 G	Presser Spring Regulator, for use with assembly No. 29480 CY
63430 C	Presser Foot Bottom, 3/8 inch wide, for use with assembly No. 29480 CY; for top stitching collars (feed dog No. 61405 J, throat plate No. 61424 J-063)
63430 D	Presser Foot Bottom, 9/16 inch wide, similar to No. L452 except 1/4 inch longer in rear, for use with assembly No. 29480 CY; for run stitching collars (feed dog No. 61405 AH, throat plate No. 61424 AH-063)
63457 B	Presser Bar, for assembly No. 29480 CY
63457 C	Presser Bar Bushing, lower, for use with assembly No. 29480 CY
63457 D	Presser Guide Plunger, for assembly No. 29480 CY
63457 E	Plunger Collar, for assembly No. 29480 CY
63457 F	Presser Bar and Plunger Holder, for assembly No. 29480 CY
63457 G	Spring, for assembly No. 29480 CY
K67092	Roller Presser Foot Assembly (screw Nos. 22765, 22845 B, 22894 C, 22894 F, spring washer No. 39198 D, roller assembly No. 52130 D, roller presser foot arm No. 52130 F, roller presser foot swing-out collar No. K67093, roller presser foot presser bar No. K67096)
K67093	Roller Presser Foot Swing-out Collar, for assembly No. K67092
K67096	Roller Presser Foot Presser Bar, for assembly No. K67092

NOTE: Use No. 61257 G presser spring regulator, No. 63457 C lower presser bar bushing and No. 63457 H presser bar, when mounting a quilting guide. PL480 shows installation.

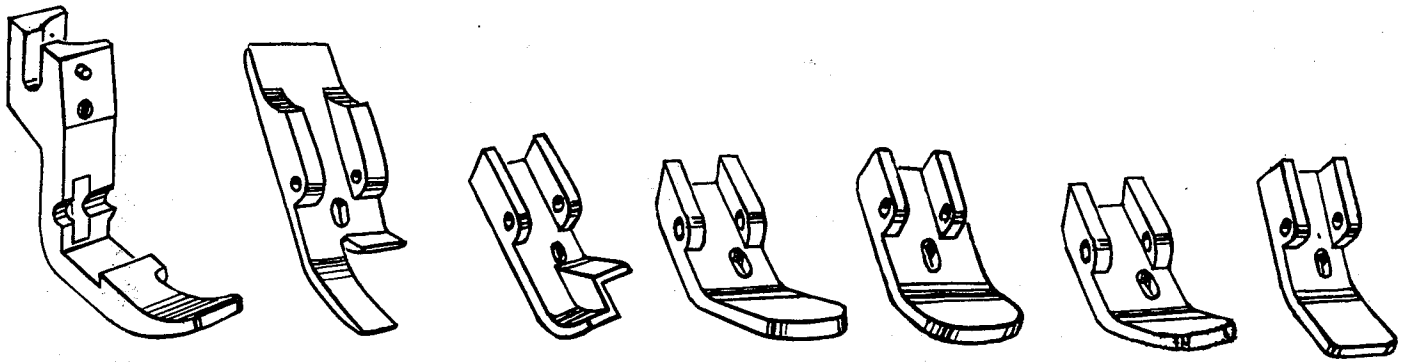

61330 M 61330 C 61430 S 61330 Y 61330 AE 61430 Y 61430 T

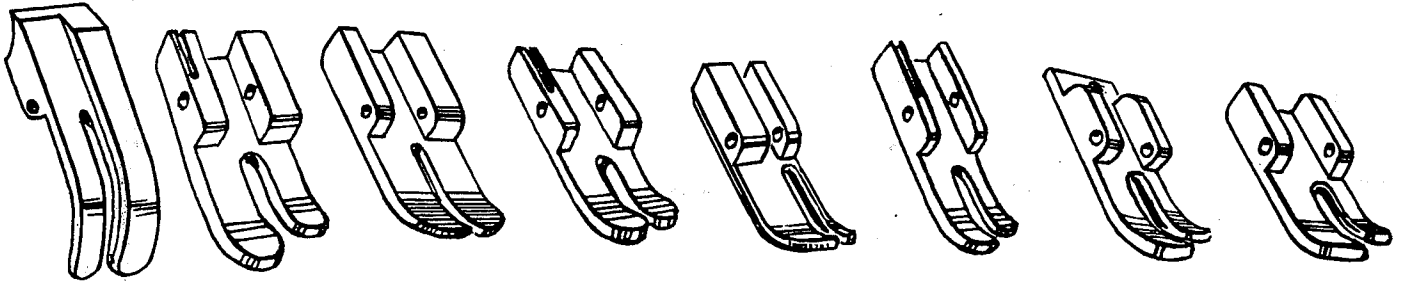

61330 L 61430 AB 61430 AC 61330 T 61330 AW 61430 AS 61430 C 61330 AG

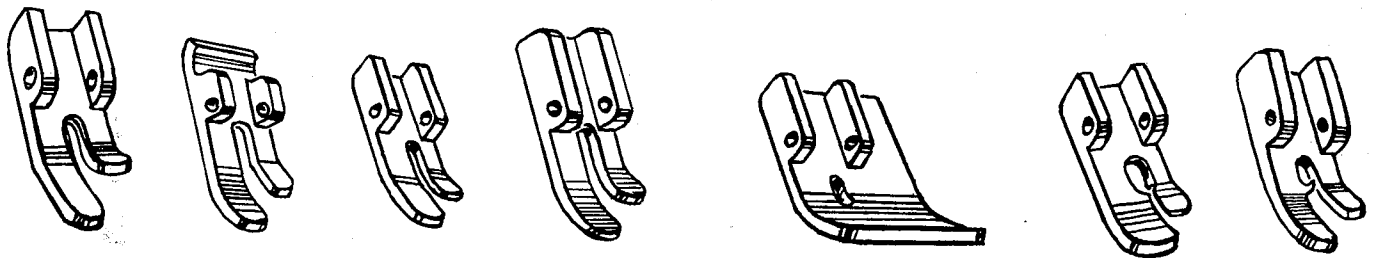

61330 Z 61330 AB 61330 AU 61330 R 61330 AD 61330 AF 61230 F

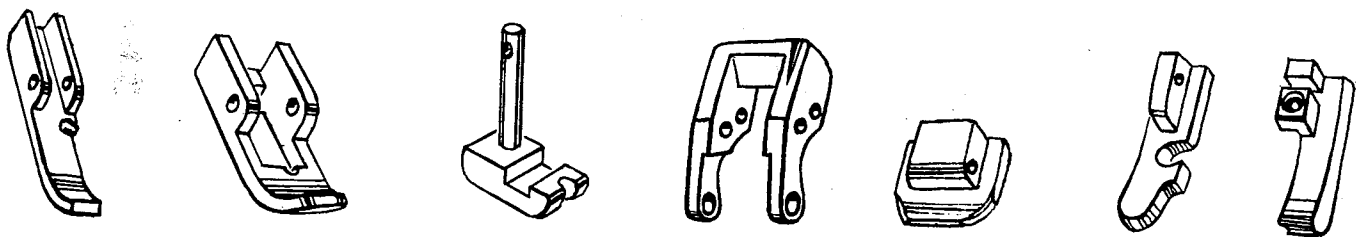

61330 AX 61330 W 61330 V 35730 D 35730 C 61230 L 61230 M

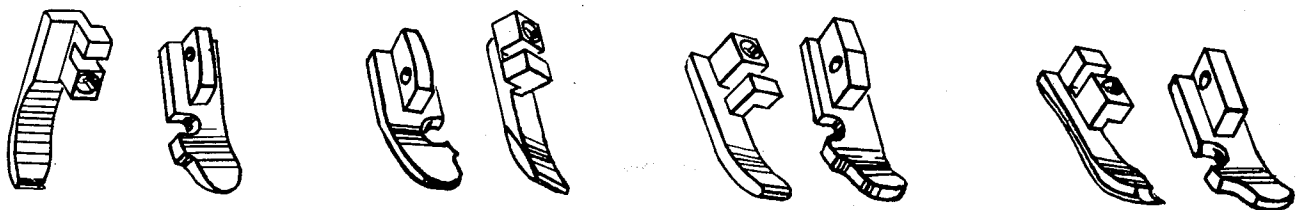

61230 W 61230 V 61330 AJ 61330 AL 61330 AN 61330 AM 61330 AS 61330 AR

PRESSER FEET BOTTOMS AND YIELDING SECTIONS

<u>Part No.</u>	<u>Description</u>
35730 C	Rear Section, for presser foot No. L556
35730 D	Yoke, for presser foot No. L556
61230 F	Bottom, for presser foot No. L218
61230 L	Bottom, for presser foot No. 61220 S
61230 M	Yielding Section, for presser foot No. 61220 S
61230 V	Bottom, for presser foot No. 61220 W
61230 W	Yielding Section, for presser foot No. 61220 W
61330 C	Bottom, for presser foot No. 61320 C
61330 L	Bottom, for presser foot No. 61320 L
61330 M	Main Section, for presser foot No. 61320 N
61330 R	Bottom, for presser foot No. 61320 Q
61330 T	Bottom, for presser foot No. 61320 S
61330 V	Bottom Yielding Section, for presser foot No. L158
61330 W	Bottom, for presser foot No. L158
61330 Y	Bottom, for presser feet Nos. L293, 61220
61330 Z	Bottom, for presser feet Nos. L82 A, L326, 61220 J
61330 AB	Bottom, for presser foot No. 61320 AA
61330 AD	Bottom, for presser foot No. 61220 K
61330 AE	Bottom, for presser foot No. 61220 Q
61330 AF	Bottom, for presser foot No. 61320 R
61330 AG	Bottom, for presser foot No. 61220 P
61330 AJ	Bottom, for presser foot No. 61320 AG
61330 AL	Yielding Section, for presser foot No. 61320 AG
61330 AM	Bottom, for presser foot No. 61320 AH
61330 AN	Yielding Section, for presser foot No. 61320 AH
61330 AR	Bottom, for presser feet Nos. L498 A, 61320 AJ
61330 AS	Yielding Section, left, for presser foot No. 61320 AJ
61330 AU	Bottom, for presser foot No. 61320 AD
61330 AW	Bottom, for presser foot No. 61320 AL
61330 AX	Bottom, for presser foot No. 61320 AM
61430 C	Bottom, for presser foot No. 61420 C
61430 S	Bottom, for presser foot No. 61420 BD
61430 T	Bottom, for presser foot No. 61420 BR
61430 Y	Bottom, for presser foot No. 61420 BT
61430 AB	Bottom, for presser foot No. 61420 BU
61430 AC	Bottom, for presser foot No. 61420 BV
61430 AS	Bottom, for presser foot No. 61420 BY

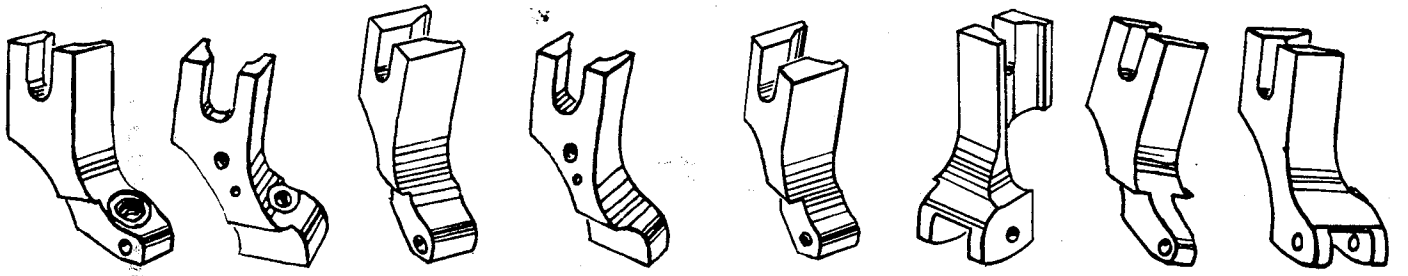

61330 AH 61430 AA 61330 61430 AT 61330 AC 61230 X 61330 AV 61330 AK

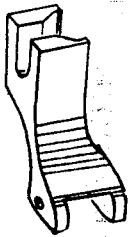

61230 S

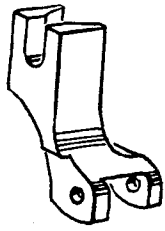

61330 AP

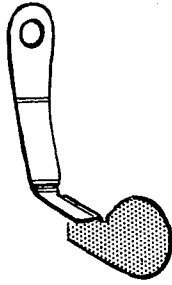

61430 N

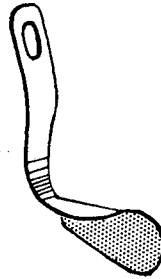

L683



61330 F

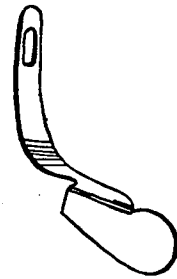

61330 E



61230 U

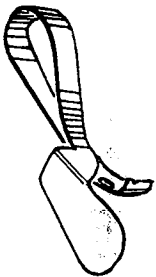

L122 A

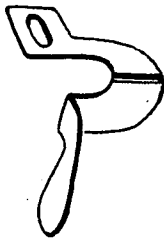

61430 M



61330 N



61230 A-1/8



61430 P



61230 5/32



61230 B-1/8



L774



L158 A

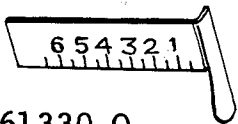

61330 Q



1741 B



12957 E



20

1741 A

61330 B



21657 E



61303 D



51430 F

61230 C



61230 J



61330 P



61430 A



61430 B



T29

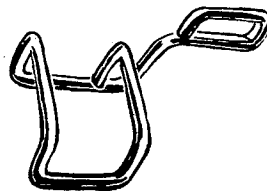

61231 A



61430 BB



1230 B



51930



61230 AK



L314 A

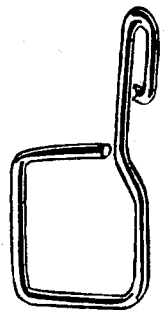

61231

PRESSER FEET SHANKS, SPRINGS, SCROLLS AND GUIDES

<u>Part No.</u>	<u>Description</u>
20	Washer, for hemmer swing-out bracket Nos. K51606, K51623
T29	Thumb Nut, for edge guide assembly No. L367
L122 A	Spring Guide, for presser foot No. L653
L158 A	Scroll, for presser foot No. L868
L314 A	Spring, for tilting bottom on presser foot No. L556
L683	Spring Guide, for presser feet Nos. L336, L415, L637
L774	Hemmer Scroll, for presser foot No. L30
1230 B	Spring, for presser foot No. L158
1741 A	Pin, for knife on presser foot No. L218
1741 B	Chain Cutting Knife, for presser foot No. L218 (screw No. 187 A)
12957 E	Spring Washer, for plate hemmer Nos. L32, L367, L390, L394, L524, K51606, K51623
21657 E	Washer, for pivot screw on edge guide No. L367
51430 F	Hinge Adjusting Screw Nut, for presser feet Nos. L82 A, L293, L566, L943, 61420 H, 61420 T, 61420 AS, 61420 BR, 61420 BT, 61420 BU, 61420 BV, 61420 CM
51930	Spring, for tilting bottom of presser feet Nos. L39 A, L412, L498 A, L653, L875, 61220 K, 61220 P, 61220 Q, 61220 S, 61220 W, 61320 AA, 61320 AG, 61320 AH, 61320 AJ, 61420 C, 61420 AN, 61420 AV
61230-5/32	Hemmer Scroll, for presser feet Nos. L175, L756, 61220 C-1/8, 5/32, 3/16, 1/4, 61220 D-1/8, 61220 L-5/32
61230 A-1/8	Hemmer Scroll, for presser feet Nos. L727, 61220 AA-1/8
61230 B-1/8	Hemmer Scroll, for presser feet Nos. 61220 B-1/8, 5/32
61230 C	Scroll Pin, for presser feet Nos. L292, L727, L868, 61220 B-1/8, 5/32, 61220 AA-1/8
61230 J	Scroll Pin, for presser feet Nos. L175, 61220 D-1/8, 61220 L-5/32
61230 S	Shank, for presser foot No. 61220 S
61230 U	Spring Guide, for presser feet Nos. 61220 AC, 61320 U
61230 X	Shank, for presser feet Nos. L498 A, 61220 W, 61320 AJ
61230 AK	Spring, for tilting bottom of presser feet Nos. L326, 61220 K, 61320 AD
61231	Finger Guard, attaches to presser foot
61231 A	Finger Guard, attaches to presser foot
61303 D	Washer, for adjustable edge guide No. 61303, also for hemmer No. L378 and swing-out bracket No. 23278 K
61330	Shank, for presser feet Nos. L64, L72, L95, L218, L220, L313, L380, L408, L505, 61220, 61220 J, 61220 P, 61320 C, 61320 L, 61320 Q, 61320 S, 61420 C, 61420 AD, 61420 AE, 61420 AP, 61420 AU, 61420 AW, 61420 AY, 61420 BJ, 61420 BN
61330 B-29	Hinge Pin, 29/64 inch long
61330 B-31	Hinge Pin, 31/64 inch long
61330 B-35	Hinge Pin, 35/64 inch long
61330 B-39	Hinge Pin, 39/64 inch long
61330 E	Spring Guide, for presser feet Nos. 61320 E, 61320 V
61330 F	Spring Guide, for presser feet Nos. 61320 F, 61320 AE
61330 N	Spring, for adjustable guide on presser feet Nos. L769, 61320 N
61330 P	Spring Release Lever, for presser feet Nos. L769, 61320 N
61330 Q	Adjustable Guide, for presser foot No. 61320 N
61330 AC	Shank, for presser feet Nos. L195, L266, L326, L412, L525, L875, K51687, 61220 K, 61220 Q, 61320 R, 61320 AA, 61320 AD, 61420 Z, 61420 BD
61330 AH	Shank, for presser feet Nos. L82 A, L293, L566, L943, 61420 H, 61420 T, 61420 AS, 61420 BR, 61420 BT, 61420 CM
61330 AK	Shank, for presser foot No. 61320 AG
61330 AP	Shank, for presser foot No. 61320 AH
61330 AV	Shank, for presser feet Nos. 61320 AL, 61320 AM, 61420 AZ, 61420 BK
61430 A	Knife, chain cutter for presser foot No. 61420 C
61430 B	Knife Guard, for presser foot No. 61420 C
61430 M	Spring Guide, for presser foot No. 61420 K
61430 N	Spring Guide, for presser foot No. 61420 L
61430 P	Scroll, for presser foot No. 61420 AC
61430 AA	Shank, for presser feet Nos. 61420 BU, 61420 BV
61430 AT	Shank, for presser foot No. 61420 BY
61430 BB	Spring, for tilting bottom of presser feet Nos. 61420 BU, 61420 BV, 61420 BY

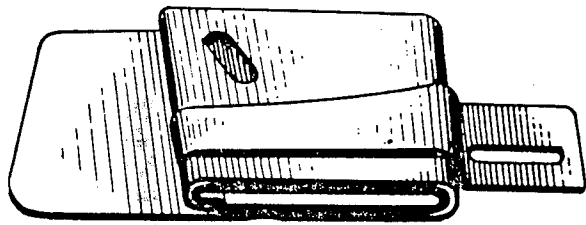

K51689

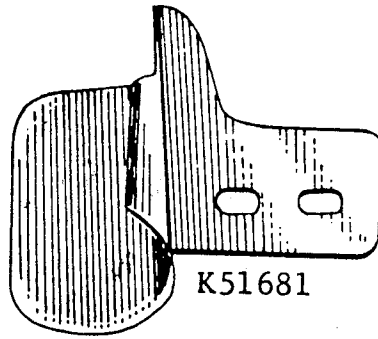

K51681

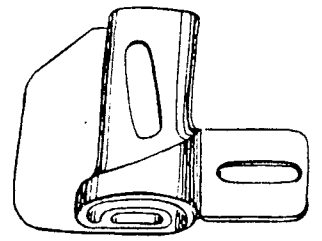

K51621

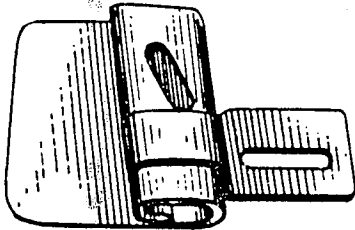

K51688

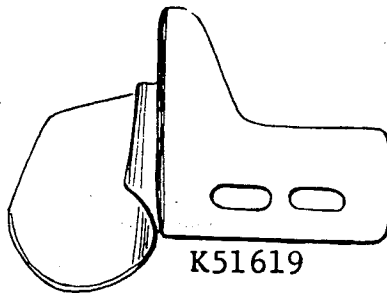

K51619

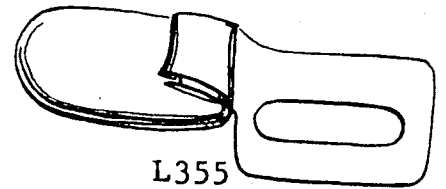

L355

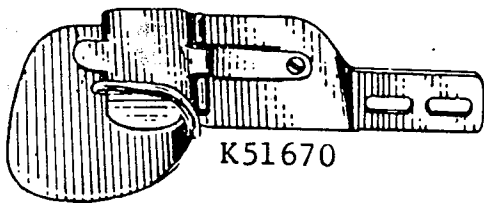

K51670

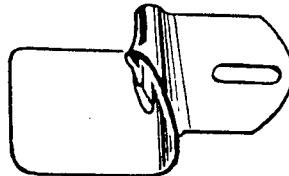

L327

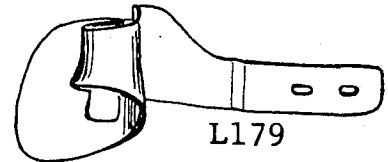

L179

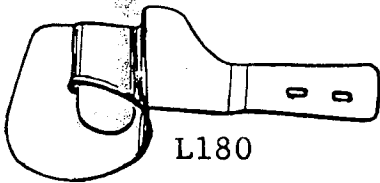

L180

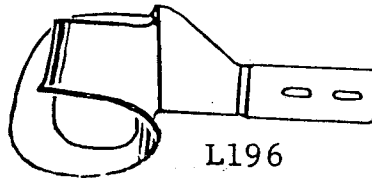

L196

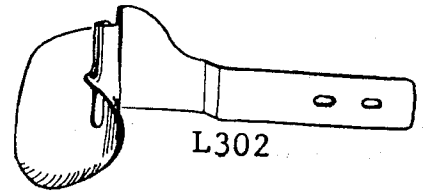

L302

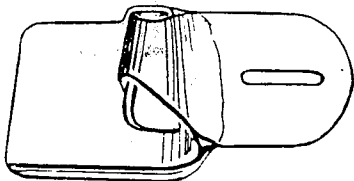

L564

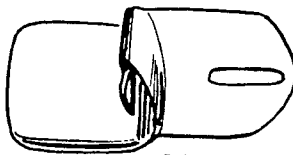

23510

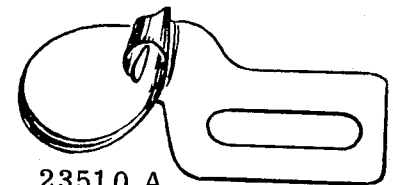

23510 A

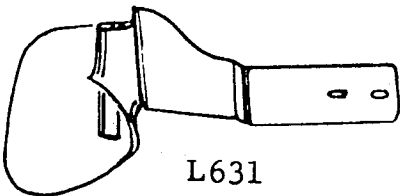

L631



L378

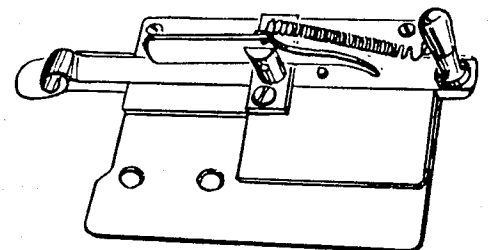

L96

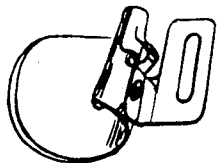

L385



L516

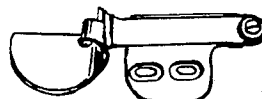

L394

HEMMERS

<u>Part No.</u>	<u>Description</u>
L96	Hemming shirt tails, has retractable scroll, for 3/16 inch hem; feed dog No. 61205 CA, throat plate No. 61224 C-063, presser foot No. 61420 BN (attaching screw No. 25 C, locking lever screw No. 22585, gib screw No. 90)
L179	Hemming upholstery, 1/16 inch capacity, hem turned up, with underlap of 7/16 inch, finishes 1 inch, attached to swing-out bracket No. K51623; feed dog No. 61205 A, throat plate No. 61224 C-073, presser foot No. 61220 K (screw No. 22570)
L180	Hemming drapery material, 3/32 inch capacity, hem turned up, finishes 1 1/2 inches, attached to swing-out bracket No. K51623; feed dog No. 61205 A, throat plate No. 61224 C-073, presser foot No. 61220 K (screw No. 22570)
L196	Hemming drapery material, attached to swing-out bracket No. K51623, hem turned up, finishes 2 inches, 7/16 inch underlap; feed dog No. 61205 A, throat plate No. 61224 C-063, presser foot No. 61420 H (screw No. 22570)
L302	Hemming drapery material, hem turned up with 5/16 inch underlap, finishes 1/2 inch, attached to swing-out bracket No. K51623; feed dog No. 61205 A, throat plate No. 61224 C-073, presser foot No. 61220 T (screw No. 22570)
L327	Hemming button facings on work shirts, 1/8 inch capacity, 1/2 inch finish, attached to swing-out bracket No. 23278 K, feed dog No. 61305 A, throat plate No. 61324 A-093, presser foot No. 61320 AH (screw No. 22585 A)
L355	Hemming chambray work shirts, finishes 11/16 inch; feed dog No. 61205 A, throat plate No. 61224 C-063, presser foot No. 61420 BN (screw No. 25 C)
23510 A	Miscellaneous hemming operation on light weight material, capacity 1/16 inch, finishes 3/8 inch; feed dog No. 61205 C, throat plate No. 61224 C-063, presser foot No. 61320 AJ (screw No. 25 C)
L378	Hemming shirts, 5/64 inch capacity, finishes 5/16 inch, swing-out type; feed dog No. 61205 A, throat plate No. 61224 C-063, presser foot No. 61420 BN, (attaching screw No. 90, hemmer No. L385, hemmer attaching screw No. 90, thumb screw No. 22551, swinging bracket No. 61303 B, pivot screw No. 134, washer No. 61303 D)
L385	Hemming shirts, 5/64 inch capacity, finishes 5/16 inch; similar to No. L378 (screw No. 90)
L394	Hemming high back overalls, 1/8 inch capacity, finishes 3/8 inch, swing-out type; feed dog No. 61305 A, throat plate No. 61324 A-093, presser foot No. 61320 L (attaching screw No. 25 C, pivot screw No. 22726, washer No. 12957 E)
L516	Hemming rayon and cotton materials, capacity 1/16 inch, finishes 1/4 inch, attached to swing-out bracket No. K51623; feed dog No. 61205 C, throat plate No. 61224 C-063, presser foot No. 61420 BR (screw No. 22570)
L564	Hemming button stays, medium weight sport shirts, 5/64 inch capacity, finishes 5/8 inch hem, attached to swing-out bracket No. 23278 K; feed dog No. 61205 A, throat plate No. 61224 C-063, presser foot No. 61320 AJ (screw No. 22585 A)
L631	Hemming draperies, 1/4 inch underlap, attached to swing-out bracket No. K51623, finishes 3/4 inch; feed dog No. 61205 A, throat plate No. 61224 C-073, presser foot No. 61220 Q (screw No. 22570)
23510	Hemming button stays on work shirts, 5/64 inch capacity, finishes 1/4 inch, attached to swing-out bracket No. 23278 K; feed dog No. 61205 A, throat plate No. 61224 C-063, presser foot No. 61320 AH (screw No. 22585 A)
K51619	Hemming towels, 1/16 inch capacity, finishes 1/4 inch; feed dog No. 61205 A, throat plate No. 61224 C-063, presser foot No. 61420 BN (screw No. 25 C)
K51621	Hemming bed sheets, 1/16 inch capacity, finishes 1 inch, attached to swing-out bracket No. K51659; feed dog No. 61205 A, throat plate No. 61224 C-063, presser foot No. 61420 BG (screw No. 22711)
K51670	Hemming house dresses, 5/64 inch capacity, finishes 1 1/2 inches, attached to swing-out bracket No. K51623; feed dog No. 61205 A, throat plate No. 61224 C-063, presser foot No. 61220 K (screw No. 22570, spring No. L691)
K51681	Hemming towels, 5/64 inch capacity, finishes 3/32 inch; feed dog No. 61205 A, throat plate No. 61224 C-063, presser foot No. 61420 BN (screw No. 25 C)
K51688	Hemming bed sheets, with 3/8 inch underlap, finishes 1 inch, 1/16 inch capacity, attached to swing-out bracket No. K51659; feed dog No. 61205 A, throat plate No. 61224 C-063, presser foot No. 61420 BG (screw No. 22711)
K51689	Hemming bed sheets, with 3/8 inch underlap, 1/16 inch capacity, finishes 3 inches, attached to swing-out bracket No. K51659; feed dog No. 61205 A, throat plate No. 61224 C-063, presser foot No. 61420 BG (screw No. 22711)

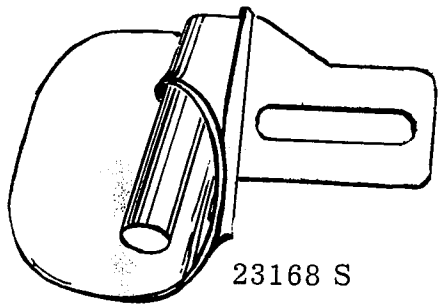

23168 S

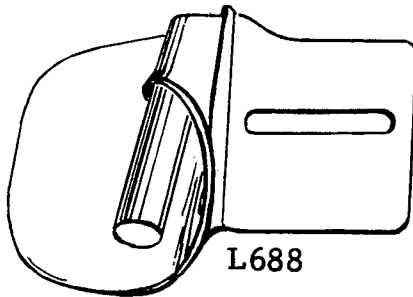

L688

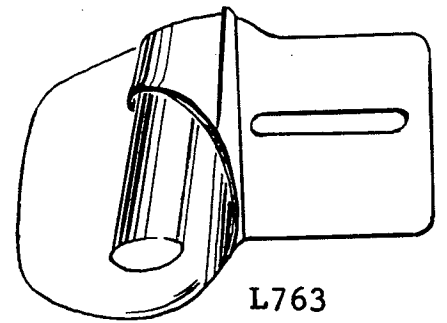

L763

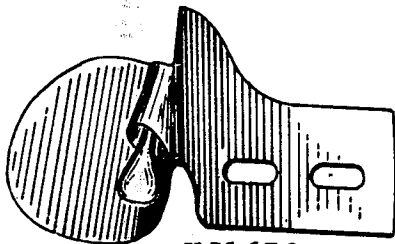

K51672

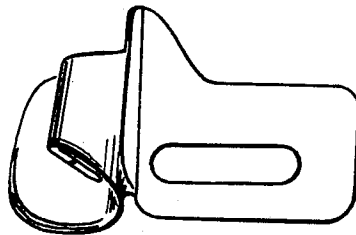

L610

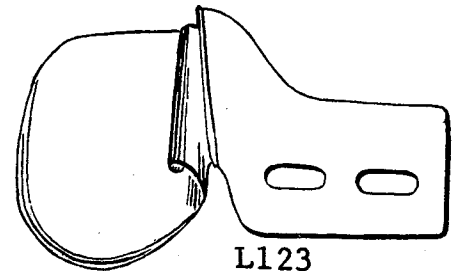

L123

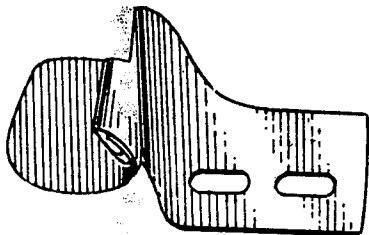

K51650

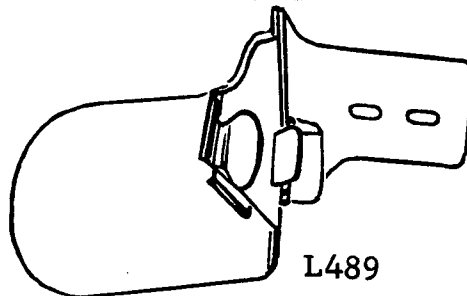

L489

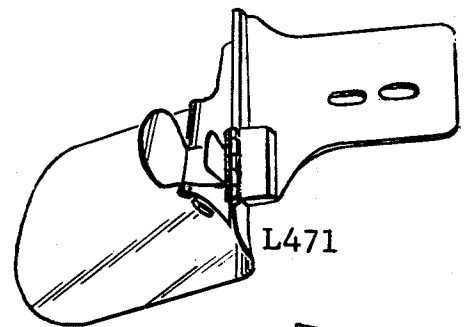

L471

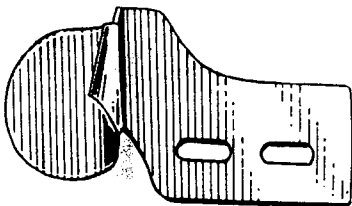

K51649

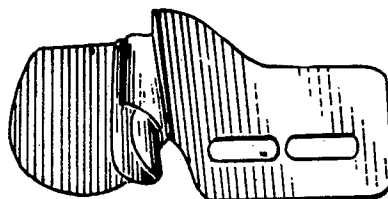

L3

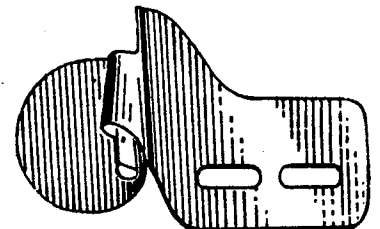

L11

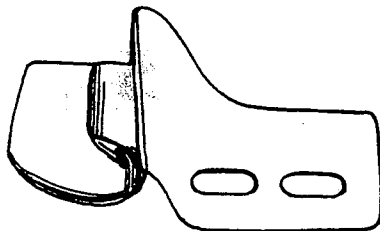

L265

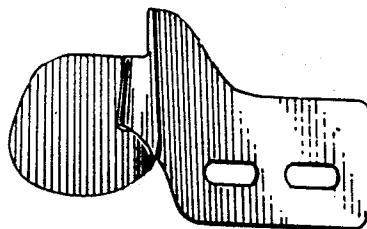

K51669

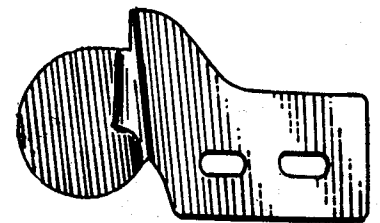

K51668

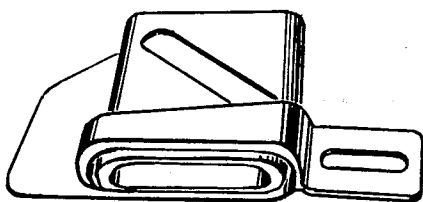

L122

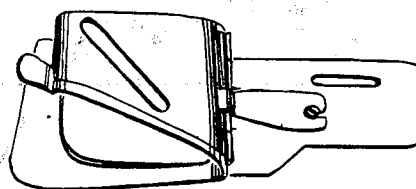

L154

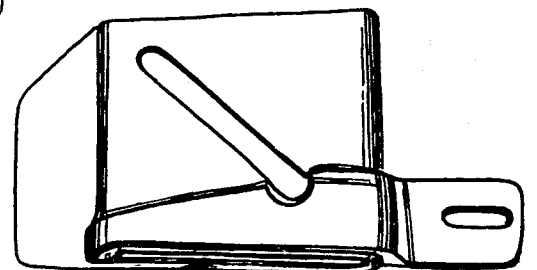

K51622

HEMMERS

<u>Part No.</u>	<u>Description</u>
L3	Hemming overall suspender straps, 1/16 inch capacity, finishes 5/16 inch; feed dog No. 61305 C, throat plate No. 61324 C-093, presser foot No. 61320 L (screw No. 25 C)
L11	Hemming rayon and similar materials, 3/64 inch capacity, finishes 5/16 inch; feed dog No. 61205 A, throat plate No. 61224 C-063, presser foot No. 61420 BN (screw No. 25 C)
L122	Hemming bed sheets, 1/16 inch capacity, finishes 2 inches, attached to swing-out bracket No. K51659; feed dog No. 61205 C, throat plate No. 61224 C-063, presser foot No. 61420 BG (screw No. 22711)
L123	Plate Hemmer, for garments made of muslin, 1/16 inch capacity, finishes 1/8 inch; feed dog No. 61205 C, throat plate No. 61224 C-063, presser foot No. 61420 BN (screw No. 25 C)
L154	Hemming mesh curtains, 3/32 inch capacity, finishes 3 1/4 inches, attached to swing-out bracket No. K51623; feed dog No. 61205 C, throat plate No. 61224 C-063, presser foot No. 61220 (screw No. 22570)
L265	Hemming men's shorts, 1/2 inch finished hem; feed dog No. 61205 C, throat plate No. 61224 C-063, presser foot No. 61420 BN (screw No. 25 C)
L471	Hemming sleeves and work shirts, finishes 1/2 inch; feed dog No. 61205 A, throat plate No. 61224 C-063, presser foot No. 61320 AJ (screw No. 22585 A)
L489	Hemming sleeves and bottom of sport shirts, finished 3/4 inch; feed dog No. 61205 A, throat plate No. 61224 C-063, presser foot No. 61220 K (screw No. 22585 A)
L610	Hemming men's shorts, finishes 3/4 inch; feed dog No. 61205 C, throat plate No. 61224 C-063, presser foot No. 61220 (screw No. 25 C)
L688	Miscellaneous hemming operations, capacity 1/16 inch, finishes 5/8 inch, 1/4 inch underlap; feed dog No. 61205 A, throat plate No. 61224 C-063, presser foot No. L505 (screw No. 25 C)
L763	Hemming herringbone twill, 1/16 inch capacity, finishes 7/8 inch, 1/4 inch underlap; feed dog No. 61305 A, throat plate No. 61324 A-093, presser foot No. 61420 H (screw No. 25 C)
23168 S	Miscellaneous hemming operations, 3/32 inch capacity, finishes 11/16 inch; feed dog No. 61305 D, throat plate No. 61324 D-093, presser foot No. 61420 BN (screw No. 25 C)
K51622	Hemming bed sheets, 1/16 inch capacity, finishes 3 inches, attached to swing-out bracket No. K51659; feed dog No. 61205 A, throat plate No. 61224 C-063, presser foot No. 61420 BG (screw No. 22711)
K51649	Hemming muslin garments, 3/64 inch capacity, finishes 1/8 inch; feed dog No. 61205 A, throat plate No. 61224 C-063, presser foot No. 61220 T (screw No. 25 C)
K51650	Hemming men's woven shorts, 5/64 inch capacity, finishes 3/8 inch; feed dog No. 61205 C, throat plate No. 61224 C-063, presser foot No. 61220 T (screw No. 25 C)
K51668	Hemming muslin garments, capacity 5/64 inch, finishes 3/16 inch; feed dog No. 61205 C, throat plate No. 61224 C-063, presser foot No. 61220 T (screw No. 25 C)
K51669	Hemming men's woven shorts, 5/64 inch capacity, finishes 1/4 inch; feed dog No. 61205 C, throat plate No. 61224 C-063, presser foot No. 61420 BN (screw No. 25 C)
K51672	Hemming overall suspender straps, 5/64 inch capacity, finishes 5/16 inch; feed dog No. 61305 C, throat plate No. 61324 C-093, presser foot No. 61320 C (screw No. 25 C)

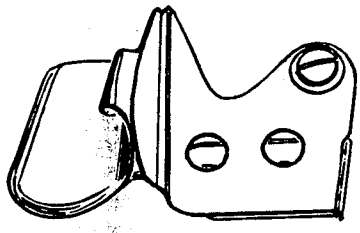

L524

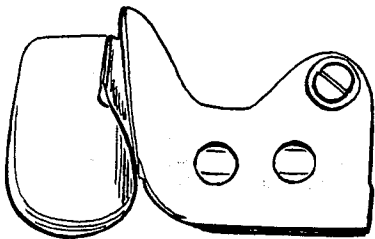

L32

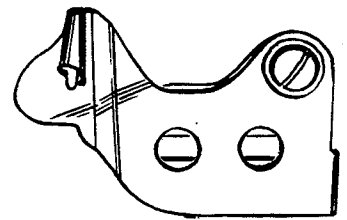

L390

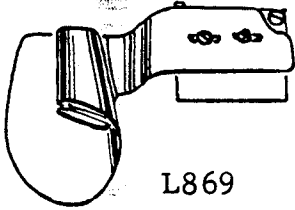

L869

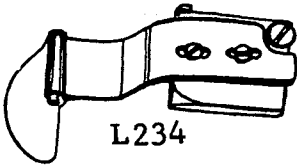

L234

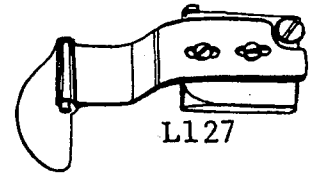

L127

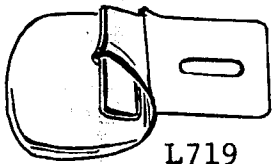

L719



L599

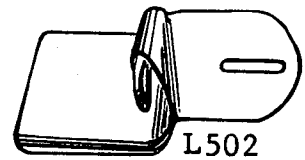

L502

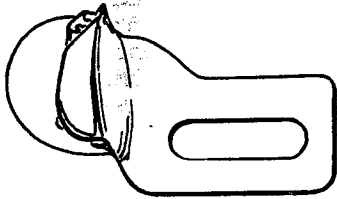

L531

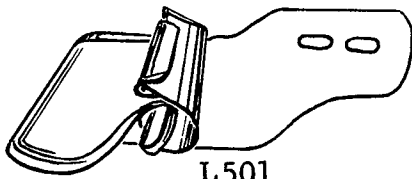

L501

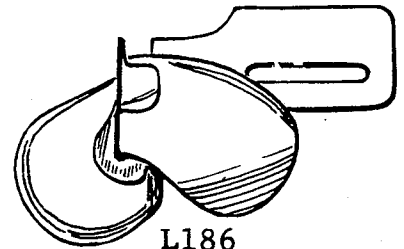

L186

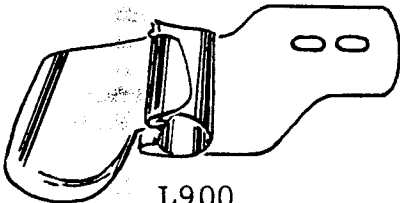

L900

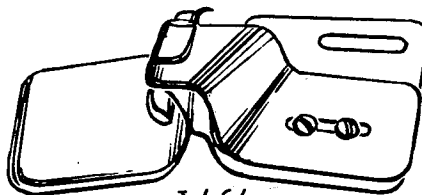

L464

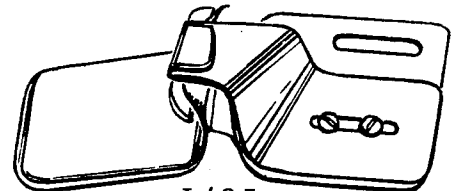

L495

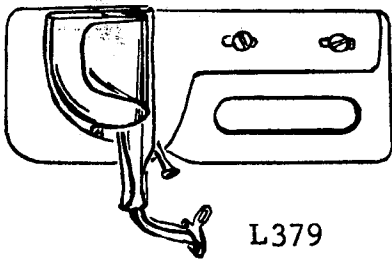

L379

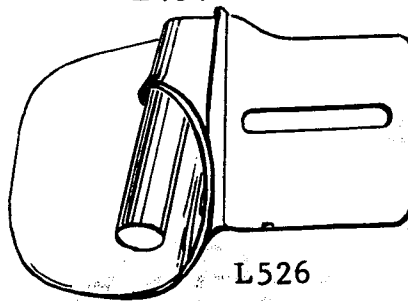

L526

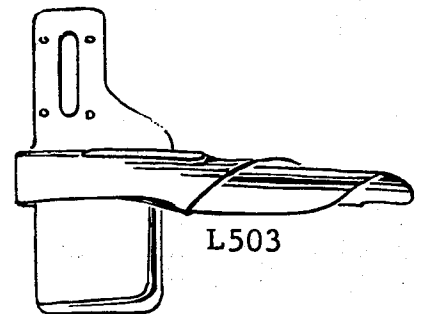

L503

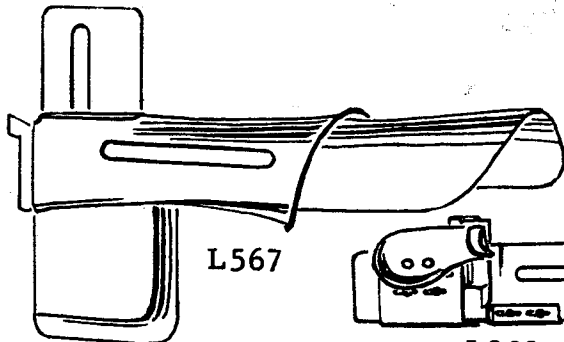

L567

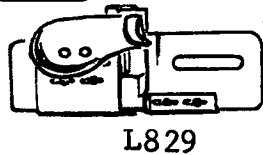

L829

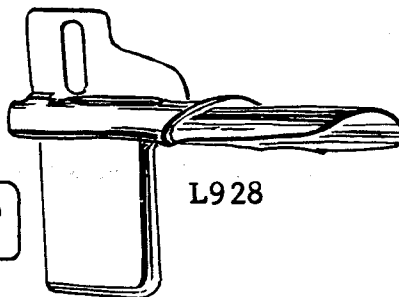

L928

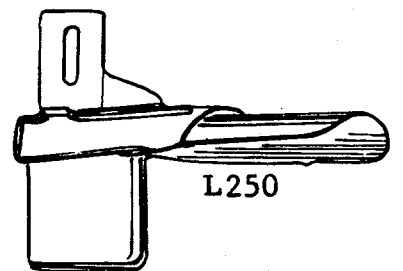

L250

HEMMERS AND FOLDERS

<u>Part No.</u>	<u>Description</u>
L32	Hemming heavy work shirts, swing-out type, finishes 3/16 inch; feed dog No. 61205 A, throat plate No. 61224 C-063, presser foot No. 61320 AJ (pivot screw No. 22726, washer No. 12957 E) (screw No. 25 C)
L127	Hemming work shirts, 3/64 inch capacity, finishes 1/4 inch, swing-out type; feed dog No. 61205 C, throat plate No. 61224 C-063, presser foot No. 61420 BN (pivot screw No. 22760 A, scroll screw No. 22561) (screw No. 25 C)
L186	Folder and Guide, capacity 3/64 inch, finishes 3/16 inch, lower ply turned upward, top ply enters from right; feed dog No. 61205 A, throat plate No. 61224 C-063, presser foot No. 61220 Q (screw No. 25 C)
L234	Hemming work shirts, swing-out type, finishes 5/16 inch; feed dog No. 61205 C, throat plate No. 61224 C-063, presser foot No. 61420 BN (scroll screw No. 22561, pivot screw No. 22760 A) (screw No. 25 C)
L250	Folder, for attaching sleeve facings, light weight material, 1/32 inch capacity, 2 5/8 inch width of strip, finishes 1 1/8 inches; feed dog No. 61405 K, throat plate No. 61424 K-063, presser foot No. 61420 H (screw No. 25 C)
L379	Folder, for cording and piping pajama coats, uses 5/8 inch bias cut tape and 3/32 diameter cord; feed dog No. 61305 B, throat plate No. 61324 B-063, presser foot No. L380 (screw No. 25 C)
L390	Hemming handkerchiefs, swing-out type, 3/64 inch capacity, finishes 3/32 inch; feed dog No. L369, throat plate No. L391, presser foot No. 61320 AJ (pivot screw No. 22726, washer No. 12957 E) (screw No. 25 C)
L464	Folder and Guide, making pants flies on heavy material, lower ply turned upward, top ply enters from right, 1/16 inch capacity; feed dog No. 61305 Q, throat plate No. 61324 Q-063, presser foot No. 61420 AP (attaching screw No. 22585 A, guide screw No. 22825)
L495	Folder and Guide, making pants flies on medium weight materials, 1/32 inch capacity, lower ply turned upward, top ply enters from right; feed dog No. 61305 Q, throat plate No. 61324 Q-063, presser foot No. 61420 AP (attaching screw No. 22585 A, guide screw No. 22825)
L501	Double Edge Folder, for joining shoulder seams on shirts, capacity 3/64 inch; feed dog No. 61205 C, throat plate No. 61224 C-063, presser foot No. L506 (screw No. 22585 A)
L502	Hemming overall suspender straps, capacity 5/64 inch, finishes 5/16 inch, attached to swing-out bracket No. 23278 K; feed dog No. 61305 A, throat plate No. 61324 A-093, presser foot No. 61320 L (screw No. 22585 A)
L503	Folder, for gabardine and light weight flannel sport shirts, 3/64 inch capacity, 2 5/8 inch width of strip, finishes 1 1/8 inches; feed dog No. 61405 K, throat plate No. 61424 K-063, presser foot No. 61420 H (screw No. 25 C)
L524	Hemming shirts and similar garments, swing-out type, finishes 3/8 inch; feed dog No. 61205 D, throat plate No. 61224 F-063, presser foot No. 61420 BN (pivot screw No. 22726, washer No. 12957 E) (screw No. 25 C)
L526	Folder, for light weight Army cloth, 1/32 inch capacity, finishes 11/16 inch; feed dog No. 61305 D, throat plate No. 61324 D-093, presser foot No. 61220 K (screw No. 25 C)
L531	Double Edge Folder, for broadcloth, 1/32 inch capacity; feed dog No. 61205 A, throat plate No. 61224 C-063, presser foot No. 61220 (screw No. 25 C)
L567	Folder, for attaching pajama cuffs, 5/16 inch margin to left of needle, 1/32 inch capacity, 5 inch width of strip, finishes 2 1/4 inches; feed dog No. 61405 K, throat plate No. 61424 K-063, presser foot No. 61420 S (screw No. 25 C)
L599	Finishing button stays on work shirts, 5/64 inch capacity, finishes 3/16 inch hem attached to swing-out bracket No. 23278 K; feed dog No. 61205 A, throat plate No. 61224 C-063, presser foot No. 61320 AJ (screw No. 22585 A)
L719	Hemming pajama pants, finishes 1 1/8 inches; feed dog No. 61205 A, throat plate No. 61224 C-063, presser foot No. 61420 BN (screw No. 25 C)
L829	Folder, for attaching rick-rack to house dresses, 1/16 inch capacity, 1/4 inch fold; feed dog No. 61205 A, throat plate No. 61224 C-063, presser foot No. 61220 Q (rick-rack guide, right, No. 23377 A, rick-rack guide, left, No. 23377 B, screw No. 25 B) (screw No. 25 C)
L869	Hemming herringbone twill, attached to swing-out bracket, finishes 5/8 inch; feed dog No. 61205 A, throat plate No. 61224 C-063, presser foot No. L505 (scroll screw No. 22561, pivot screw No. 22760 A) (screw No. 25 C)
L900	Joining shoulder seams, has 5/16 inch underlap, 3/64 inch capacity; feed dog No. 61205 C, throat plate No. 61224 C-063, presser foot No. L506 (screw No. 22585 A)
L928	Folder, for attaching 7/8 inch flannel sleeve facings, width of strips 2 1/4 inches, 1/4 inch underlap, 3/32 inch capacity; feed dog No. 61305 K, throat plate No. 61324 J-093, presser foot No. 61220 K (screw No. 25 C)

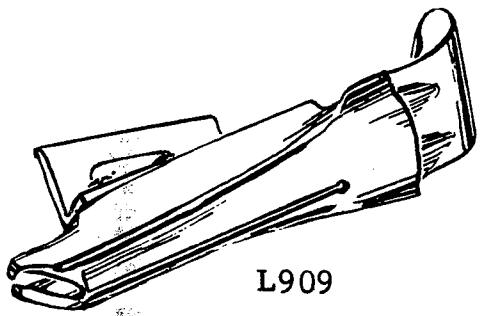

L909

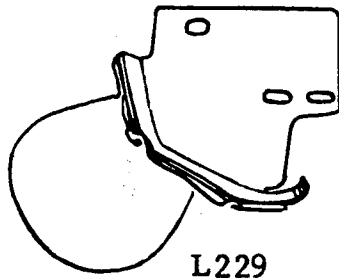

L229

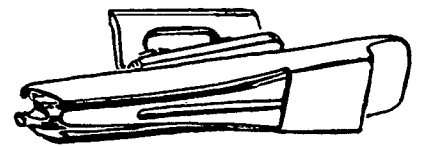

L917

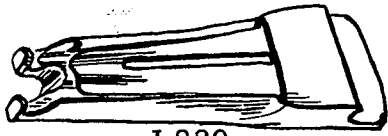

L889



K51655



K51667



K51671

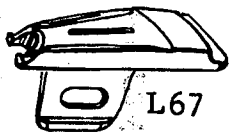

L67

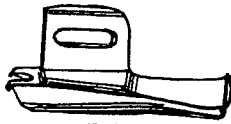

L160

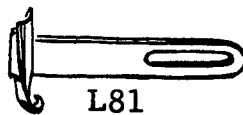

L81



K51666



L289

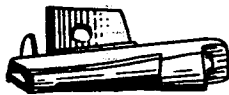

L18



K51699



K51677



L766



L77



L89



L184



L125

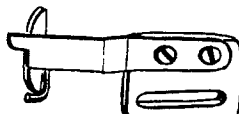

61203 B

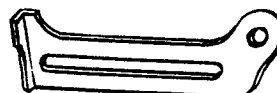

61303 C

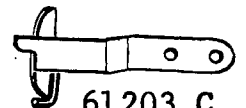

61203 C



61303 B

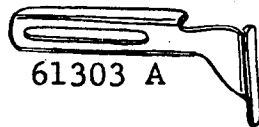

61303 A

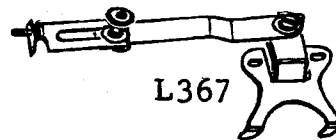

L367



L310

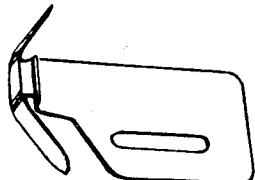

L366



L377



61203 D

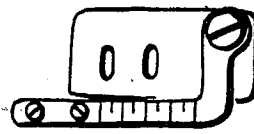

23278K

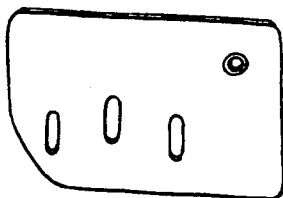

K51624

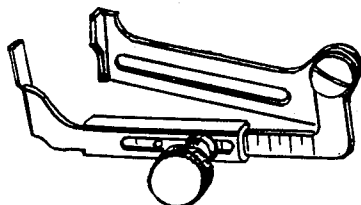

61303



K51626

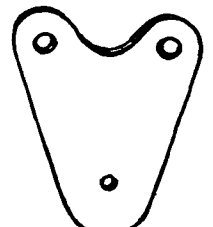

L212

BINDERS, GUIDES AND MISCELLANEOUS PARTS

<u>Part No.</u>	<u>Description</u>
L18	Cut Edge Binder, for 13/16 inch bias binding for heavy woolens, 3/16 inch finish; feed dog No. 61305 B, throat plate No. 61224 D-093, presser foot No. 61220 H (screw No. 22649 F-16)
L67	Cut Edge Binder, for 1 inch bias binding for melton, 7/32 inch finish, 3/64 inch capacity; feed dog No. 61305 B, throat plate No. 61224 D-093, presser foot No. 61220 H (screw No. 22649 F-16)
L77	Selvage Edge Binder, for 5/8 inch binding on mattress ticks, 5/16 inch finish, 3/64 inch capacity; feed dog No. 61305 B, throat plate No. 61224 D-093, presser foot No. 61220 H (screw No. 22649 F-16)
L81	Selvage Edge Binder, for 1/2 inch binding on mattress ticks, 1/4 inch finish; feed dog No. 61305 B, throat plate No. 61224 D-093, presser foot No. L235 (screw No. 22585 A)
L89	Selvage Edge Binder, for 1/2 inch binding, 1/4 inch finish, has 5/32 inch jaw capacity; feed dog No. 61305 B, throat plate No. 61224 D-093, presser foot No. 61220 H (screw No. 22649 F-16)
L125	Edge Guide, 7/8 inch guide surface (screw No. 22585 A)
L160	Selvage Edge Binder, for mattress ticks, ornamental binding, 11/16 inch width of strips, 11/32 inch finish, 1/16 inch capacity; feed dog No. 61305 B, throat plate No. 61224 D-093, presser foot No. 61220 H (screw No. 22649 F-16)
L184	Selvage Edge Binder, for lightweight material, 1/32 inch capacity, for 1/2 inch binding, 1/4 inch finish; feed dog No. 61305 B, throat plate No. 61324 B-093, presser foot No. 61220 H (screw No. 22649 F-16)
L212	Base, for swing-out bracket No. K51659 (screw No. 94)
L229	Cut Edge Binder, for 11/16 inch bias binding for pocket facings, top ply folded and lower ply raw, finishes 3/16 inch on top and approximately 5/16 inch on the bottom; feed dog No. 61305 B, throat plate No. 61324 B-093, presser foot No. 61420 T (screw No. 22649 F-16)
L289	Selvage Edge Binder, for 11/16 inch binding, 11/32 inch finish; feed dog No. 61305 B, throat plate No. 61324 B-093, presser foot No. 61220 H (screw No. 22649 F-16)
L310	Binder Swinging Arm Adaptor Bracket, for special binders
L366	Edge Guide, for stitching cuffs to shirts (screw No. 22585 A)
L367	Adjustable Throw-out Edge Guide, for stitching down collars (attaching screw No. 94, pivot screw No. 22726, washer No. 12957 E, thumb nut No. T29, washer No. 21657 E)
L377	Edge Guide, for use with plate hemmer No. L378 (screw No. 22585 A)
L766	Selvage Edge Binder, for 9/16 inch binding, 9/32 inch finish, 5/32 inch jaw capacity; feed dog No. 61305 B, throat plate No. 61224 D-093, presser foot No. 61220 H (screw No. 22649 F-16)
L889	Cut Edge Binder, for 5/8 inch bias binding for binding coat seams, top ply folded and lower ply raw, finishes 3/16 inch on top and 1/4 inch on the bottom; feed dog No. 61205 B, throat plate No. 61224 B-093, presser foot No. L235
L909	Cut Edge Binder, for broadcloth shirts, 1/32 inch capacity, bias cut strips 1 1/8 inch, finishes 13/32 inch; feed dog No. 61305 B, throat plate No. 61224 D-063, presser foot No. 61420 BE (screw No. 22649 F-16)
L917	Cut Edge Binder, for silk and similar material, 1/2 inch bias cut strips, 1/8 inch finish; feed dog No. L916, throat plate No. 61224 D-063, presser foot No. L235 (screw No. 22649 F-16)
23278 K	Swing-out Bracket, for small plate hemmers (attaching screw No. 22585 A, pivot screw No. 134, washer No. 61303 D, edge guide holder No. 61303 B)
K51624	Base, for Nos. 51623, K51606 (screw No. 94)
K51626	Hemmer Support, for No. K51606 (screw No. 22570), washer No. 20)
K51655	Cut Edge Binder, for 1 inch bias binding, 1/4 inch finish; 3/64 inch capacity; feed dog No. 61305 B, throat plate No. 61224 D-093, presser foot No. 61220 H (screw No. 22649 F-16)
K51666	Cut Edge Binder, for 3/4 inch bias binding, 3/16 inch finish; 3/64 inch capacity; feed dog No. 61305 B, throat plate No. 61224 D-093, presser foot No. 61220 H (screw No. 22649 F-16)
K51667	Cut Edge Binder, for 7/8 inch bias binding, 7/32 inch finish; feed dog No. 61305 B, throat plate No. 61224 D-093, presser foot No. 61220 H (screw No. 22649 F-16)
K51671	Cut Edge Binder, for 1 inch bias binding, 1/4 inch finish; 1/16 inch capacity; feed dog No. 61305 B, throat plate No. 61224 D-093, presser foot No. 61220 H (screw No. 22649 F-16)
K51677	Selvage Edge Binder, for 5/8 inch bias binding, 5/16 inch finish; 1/32 inch capacity, feed dog No. 61305 B, throat plate No. 61224 D-093, presser foot No. 61220 H (screw No. 22649 F-16)
K51699	Cut Edge Binder, for 5/8 inch straight cut binding, 5/32 inch finish; 3/64 inch capacity; feed dog No. 61305 B, throat plate No. 61224 D-093, presser foot No. 61220 H (screw No. 22649 F-16)
61203 B	Flexible Guide Assembly, for edge stitching collars and cuffs on dress shirts; one each Nos. 61203 C, 61203 D; two No. 22561 (screw No. 22585 A)
61203 C	Flexible Edge Guide, for No. 61203 B (screw No. 22561)
61203 D	Base, for No. 61203 B
61303	Adjustable Edge Guide, swing-out type for edge stitching coats and vests; one each Nos. 134, 22551, 61303 A, 61303 B, 61303 C, 61303 D (screw No. 22585 A)
61303 A	Edge Guide, for No. 61303 (screw No. 22551)
61303 B	Edge Guide Holder, for No. 61303, also for Nos. L378, 23278 K
61303 C	Edge Guide Holder Base, for No. 61303

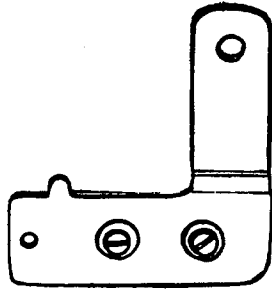

K51625

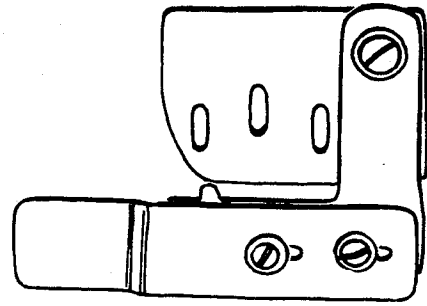

K 51606

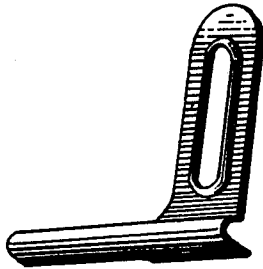

61203 A

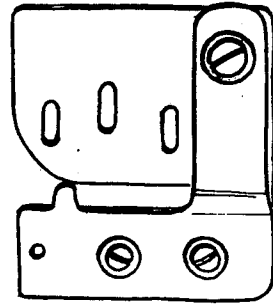

K51623

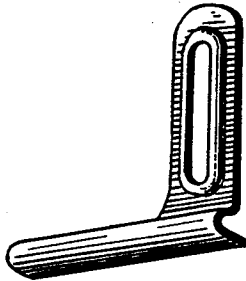

61203

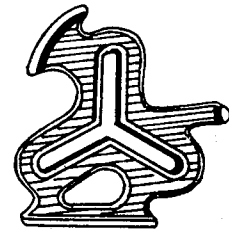

61303 E

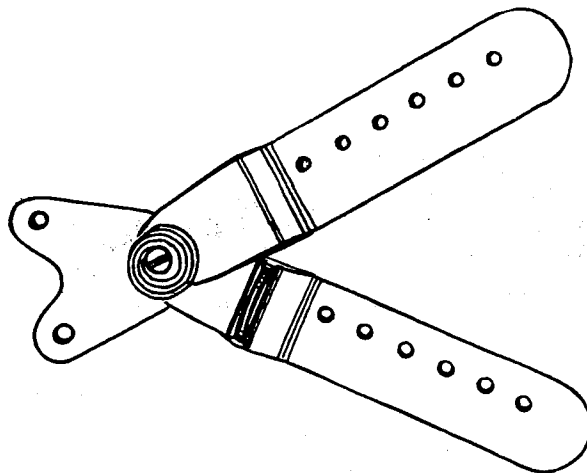

K51659

BRACKETS AND GUIDES

<u>Part No.</u>	<u>Description</u>
K51606	Swing-out Bracket, for plate hemmers with short bases; one each Nos. 12957 E, 22735, K51624, K51625, K51626; two each Nos. 20, 22570 (screw No. 94)
K51623	Swing-out Bracket, for plate hemmers with long bases; one each Nos. 12957 E, 22735, K51624, K51625; two each Nos. 20, 22570 (screw No. 94)
K51625	Swinging Arm, for Nos. 51606, K51623 (pivot screw No. 22735, washer No. 12957 E)
K51659	Swing-out Bracket, for dual plate hemmers on sheets (screw No. 94)
61203	Edge Guide, for machine with throat plates flush with bed (screw No. 22551 A)
61203 A	Edge Guide, for machine with raised throat plate (screw No. 22551 A)

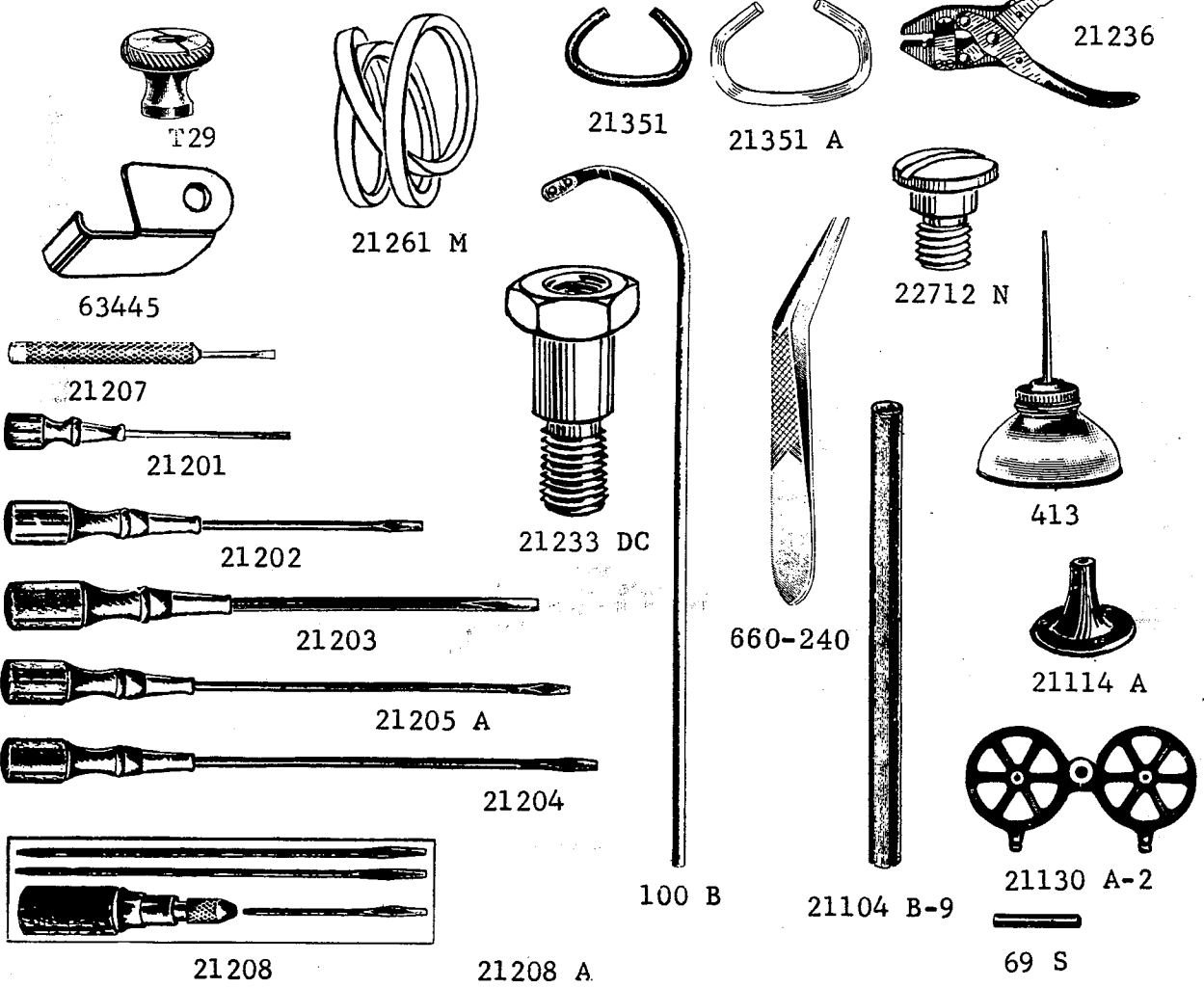
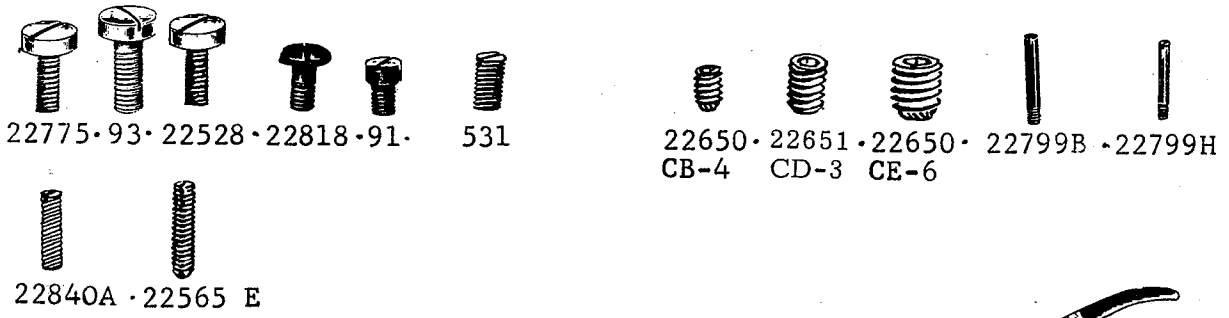
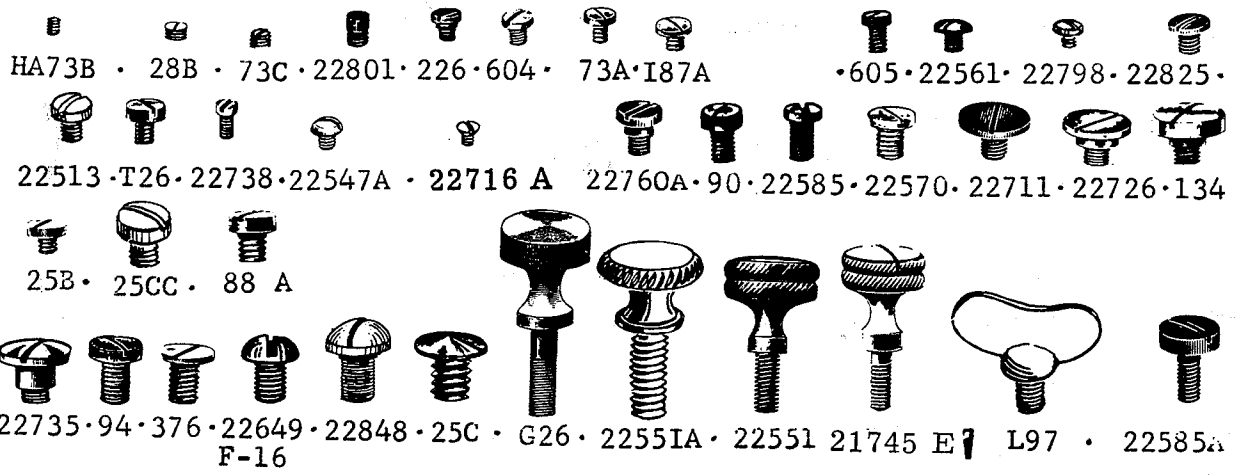

From the library of: Diamond Needle Corp

SCREWS AND MISCELLANEOUS PARTS

<u>Part No.</u>	<u>Description</u>
25 B	Screw, for folder No. L829
25 C	Screw, for attachment mounted on bed
25 CC	Screw, for hemmer No. L379
G26	Thumb Screw, for edge guide No. 61303 E
T26	Screw, for spring No. 21240 F, on quilting guide No. 21240 A
28 B	Screw, for presser foot No. 63420 D
T29	Screw, for hemmer No. L367
69 S	Spool Pin, 4 inches long
73 A	Screw, for knife guard No. 61430 B on presser foot No. 61420 C; also for presser feet Nos. L653, 61420 C, 61420 BW, 63420 D
73 C	Screw, for presser feet Nos. 61420 BW, 63420 D
HA73 B	Screw, for presser foot No. 61420 BW
88 A	Screw, for hemmer No. L889
90	Attaching Screw, for plate hemmer No. L385, used on complete hemmer No. L378; also for hemmer No. L96
91	Screw, for bushing No. 21240 C, on quilting guide No. 21240 A
93	Screw, for adjustable throw-out edge guide No. L367
94	Screw, for edge guide Nos. L367, K51606, K51623
L97	Thumb Screw, for binders mounted on throat plate
100 B	Thread Stand Wire
134	Pivot Screw, for edge guides Nos. L378, 23278 K, 61303
187 A	Screw, for chain cutting knife No. 1741 B; also for presser feet Nos. L218, L336, L415, L637, 61220 AC, 61320 E, 61320 F, 61320 U, 61320 V, 61320 AE, 61420 L
226	Spring Screw, for presser feet Nos. L556, 61420 BU, 61420 BV, 61420 BY
376	Screw, for attaching throat plate
413	Oil Can
531	Screw, for hemmers Nos. L250, L503
604	Screw, for presser feet Nos. L86 A, 61420 BW
605	Screw, for presser foot No. 63420 D
660-240	Thread Tweezers
21104 B-9	Thread Stand Rod, 9 inches long; also lengths from 2 to 48 inches
21114 A	Thread Stand Base (two screw No. 22651 CD-3)
21130 A-2	Thread Stand Seat (screw No. 22650 CE-6; two screw No. 22650 CB-4)
21201	Screwdriver, 9/64 inch round blade, over-all length 7 3/8 inches
21202	Screwdriver, 3/16 inch round blade, over-all length 9 3/8 inches
21203	Screwdriver, 3/16 inch round blade, over-all length 11 3/8 inches
21204	Screwdriver, 7/32 inch round blade, over-all length 15 inches
21205 A	Screwdriver, 3/8 inch round blade, over-all length 14 5/8 inches
21207	Screwdriver, 3/32 inch round blade, over-all length 2 7/16 inches
21208	Screwdriver Set, 3 detachable blades, diameters 1/8, 7/32 and 1/4 inch
21208 A	Screwdriver Set, includes one each Nos. 21201, 21202, 21205 A
21233 DC	Adaptor Stud, for attaching old style light fixture assembly
21236	Belt Pliers, for 3/8 inch and smaller round belting
21261 M-410	"V" Belt, No. 1 size, oil resistant; outside circumference 41 inches
21261 M-420	"V" Belt; outside circumference 42 inches
21261 M-430	"V" Belt; outside circumference 43 inches
21261 M-440	"V" Belt; outside circumference 44 inches
21351	Belt Hook, wire, for 9/32 inch round belt
21351 A	Belt Hook, wire, for 3/8 inch round belt
21745 E	Thumb Screw, for presser feet
22513	Screw, for folder No. L917
22528	Screw, for feed dog holder
22547 A	Screw, for adjustable spring guide No. 61330 N on presser feet Nos. L769, 61320 N
22551	Thumb Screw, for edge guide No. 61303 and hemmer No. L378
22551 A	Thumb Screw, for edge guide Nos. 61203, 61203 A
22561	Screw, for spring guide No. 61430 M, on presser foot No. 61420 K; also for flexible guide No. 61203 C and for scroll on hemmer Nos. L127, L234, L869
22565 E	Screw, for presser feet Nos. 61420 BU, 61420 BV
22570	Attaching Screw, for plate hemmers, used on swing-out bracket No. K51623
22585	Screw, for locking lever on plate hemmer No. L96
22585 A	Screw, for edge guides Nos. L125, L366, L377, 61303; also for flexible guide assembly No. 61203 B, hemmers mounted on swing-out bracket No. 23278 K and attachment Nos. L81, L464, L471, L489, L495, L501, L900
22649 F-16	Screw, for attaching binder to throat plate
22650 CB-4	Screw, for thread stand wire No. 100 B
22650 CE-6	Screw, for thread stand seat No. 21130 A-2
22651 CD-3	Screw, for thread stand base No. 21114 A
22711	Screw, for attachments mounted on swing-out bracket No. K51659
22712 N	Screw, for attaching old style light fixture assembly
22716 A	Screw, for presser foot No. 61220 AA
22726	Pivot Screw, for hemmer Nos. L32, L390, L394, L524; also for adjustable throw-out edge guide No. L367
22735	Pivot Screw, for swing-out brackets Nos. K51606, K51623
22738	Screw, for hemmer scroll No. L727; also for presser feet Nos. L292, L756, L768, L868, 61420 AC
22760 A	Screw, for hemmers Nos. L127, L234, L869
22775	Screw, for holding presser feet
22798	Screw, for presser foot No. L875
22799 B	Hinge Screw, for presser feet Nos. L556, 61420 M, 61420 BC
22799 H	Hinge Screw, for presser foot No. 61420 AN
22801	Hinge Screw, for presser foot No. L556
22818	Axle Screw, for No. K67399
22825	Screw, for folders and guides Nos. L464, L495
22840 A	Hinge Adjusting Screw, for presser feet Nos. L82 A, L293, L566, L943, 61420 H, 61420 T, 61420 AS, 61420 BR, 61420 BT, 61420 CM
22848	Attaching Screw, rear, for swing-out guide No. 23278 K
63445	Stitch Length Lock

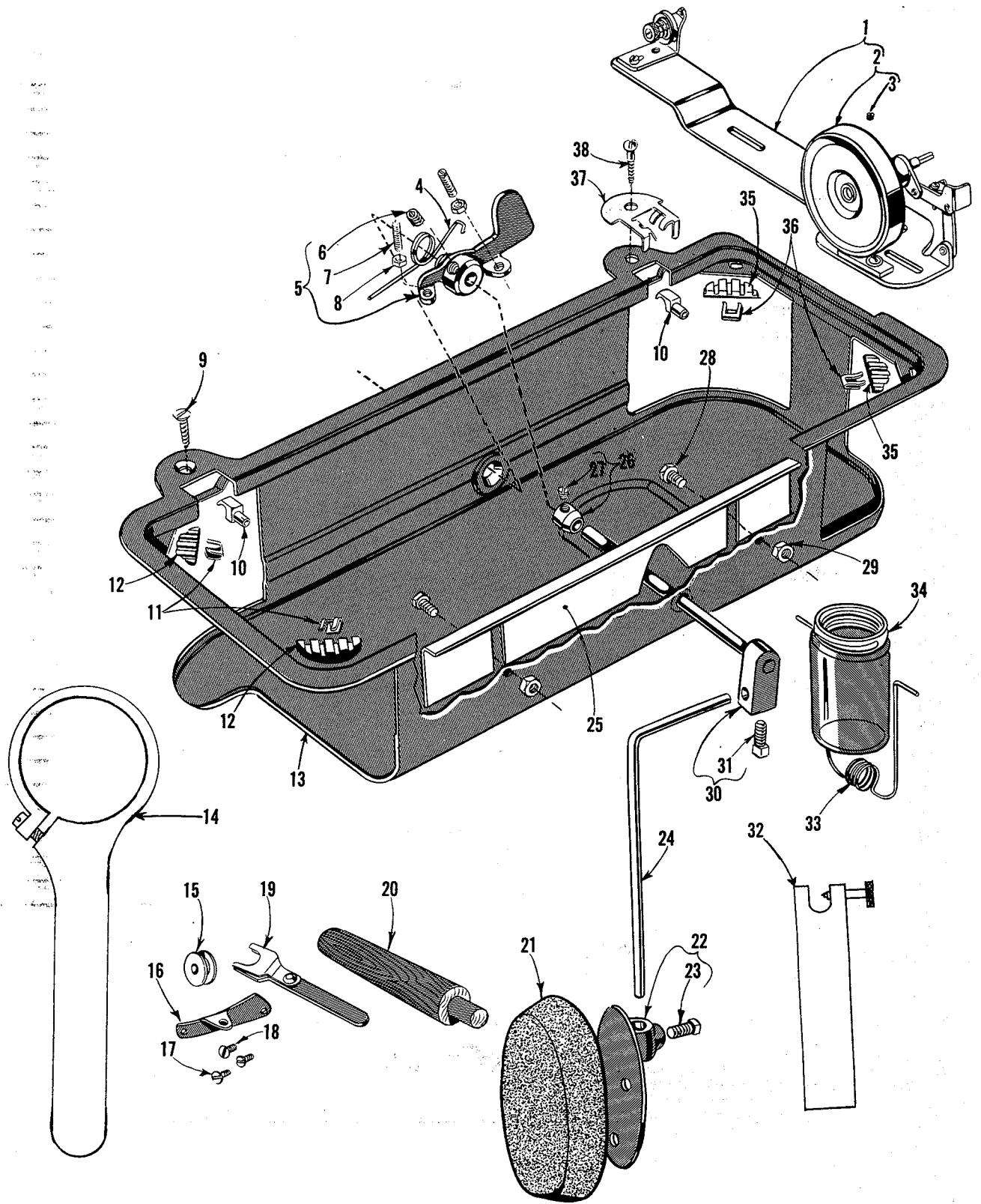

BOBBIN WINDER, KNEE PRESS AND OIL PAN ASSEMBLY

<u>Ref. No.</u>	<u>Part No.</u>	<u>Description</u>	<u>Amt. Req.</u>
1	61477 M	Bobbin Winder, complete -----	1
2	61377 Y	Pulley -----	1
3	22878	Set Screw -----	1
4	21665 E	Knee Press Spring -----	1
5	21665 J	Knee Press Lifter Lever -----	1
6	22650 AE-6	Set Screw -----	1
7	22597 F	Screw -----	2
8	18	Nut -----	2
9	22846 Q-16	Wood Screw, countersunk head -----	1
10	61375	Hinge Stud -----	2
11	63476 A	Isolator Clip, left -----	2
12	63476	Isolator Pad, left -----	2
13	21393 N	Oil Drip Pan -----	1
*14	21388 AV	Bearing Housing Puller -----	1
15	61212	Bobbin -----	1
16	61470 D	Frame Thread Eyelet -----	1
17	22570 A	Screw, for No. 61470 D -----	1
18	22585 A	Screw, for miscellaneous attachments -----	2
*19	21227 BY	Felt Assembly Adapter -----	1
20	61378	Machine Rest Pin, wood -----	1
21	660-168	Knee Press Pad, rubber -----	1
22	21664	Knee Press Plate -----	1
23	69 FD	Screw -----	1
24	21663 D	Knee Lifter Plate Rod -----	1
25	21393 R	Retaining Plate -----	1
26	21661 R	Knee Press Rod Collar -----	1
27	88	Set Screw -----	1
28	21393 S	Bolt -----	2
29	651-16	Nut -----	2
30	21661 N	Knee Press Rod -----	1
31	69 FD	Screw -----	1
*32	21227 BZ	Take-up Eyelet Replacement Tool -----	1
33	21393 L	Oil Drain Jar Clamp Spring -----	1
34	666-166	Oil Drain Jar, glass -----	1
35	63476 B	Isolator Pad, right -----	2
36	63476 C	Isolator Clip, right -----	2
37	63474 A	Bed Positioning Spring -----	1
38	SC331	Wood Screw, round head -----	1

* Not furnished with machine, but may be ordered separately as an extra send and charge item.

Presser Foot No.	Overall Width	℄ Needle Slot To Left Side	℄ Needle Slot To Right Side	Presser Foot No.	Overall Width	℄ Needle Slot To Left Side	℄ Needle Slot To Right Side
61220	15/32"	1/4"	7/32"	*61420 AG	45/64"	-	3/8"
61220 G	7/16"	7/32"	7/32"	*61420 AH	1/2"	-	3/16"
61220 H	29/64"	9/32"	11/64"	*61420 AJ	13/32"	-	1/32"
61220 J	15/32"	17/64"	13/64"	*61420 AK	11/16"	-	3/8"
61220 K	49/64"	1/4"	33/64"	*61420 AM	13/16"	-	1/2"
*61220 N	7/16"	-	1/16"	61420 AN	17/32"	1/4"	9/32"
61220 P	17/32"	19/64"	15/64"	61420 AP	37/64"	5/16"	17/64"
61220 Q	37/64"	1/4"	21/64"	61420 AR	27/64"	23/64"	1/16"
61220 R	21/64"	5/16"	1/64"	61420 AS	7/16"	1/4"	3/16"
61220 S	17/32"	1/4"	9/32"	61420 AT	5/16"	5/32"	5/32"
61220 T	13/32"	13/64"	13/64"	61420 AU	7/8"	5/16"	9/16"
61220 V	21/64"	1/64"	5/16"	61420 AV	7/16"	7/32"	7/32"
61220 W	17/32"	9/32"	1/4"	61420 AW	17/32"	19/64"	15/64"
61220 AB	23/64"	19/64"	1/16"	61420 AX	29/64"	21/64"	1/8"
*61220 AC	13/32"	-	3/64"	61420 AY	1/2"	1/4"	1/4"
61320	11/16"	15/64"	29/64"	61420 AZ	3/8"	17/64"	7/64"
61320 C	19/32"	5/16"	9/32"	61420 BB	1/4"	5/32"	3/32"
*61320 E	-	-	1/8"	61420 BD	7/16"	1/4"	3/16"
*61320 F	21/32"	-	3/16"	61420 BE	35/64"	21/64"	7/32"
61320 K	1/2"	9/32"	7/32"	61420 BG	25/64"	3/16"	13/64"
61320 L	17/32"	9/32"	1/4"	61420 BJ	31/64"	19/64"	3/16"
61320 M	5/16"	7/64"	13/64"	61420 BK	5/16"	15/64"	5/64"
†61320 N	-	-	-	61420 BN	9/16"	5/16"	1/4"
61320 P	1/2"	19/64"	13/64"	61420 BR	15/32"	17/64"	13/64"
61320 Q	17/32"	19/64"	15/64"	61420 BT	7/16"	1/4"	3/16"
61320 R	15/32"	17/64"	13/64"	61420 BU	5/8"	5/16"	5/16"
61320 S	37/64"	19/64"	9/32"	61420 BV	31/64"	15/64"	1/4"
*61320 U	1/2"	-	1/16"	61420 BY	21/64"	3/16"	9/64"
*61320 V	21/32"	-	1/8"	61420 CL	9/32"	11/64"	7/64"
61320 X	3/8"	1/4"	1/8"	61420 CM	7/8"	5/16"	9/16"
61320 AA	17/32"	19/64"	15/64"	L17	1/2"	1/4"	1/4"
*61320 AB	7/16"	-	1/16"	L39 A	13/32"	21/64"	5/64"
61320 AC	13/64"	3/32"	7/64"	L64	1/2"	9/32"	7/32"
61320 AD	15/32"	17/64"	13/64"	L72	17/32"	17/64"	17/64"
*61320 AE	21/32"	-	1/4"	L82 A	3/8"	1/4"	1/8"
61320 AF	5/16"	3/32"	7/32"	L86 A	37/64"	19/64"	9/32"
61320 AG	17/32"	1/4"	9/32"	L95	7/16"	1/4"	3/16"
61320 AH	17/32"	9/32"	1/4"	L158	5/8"	21/64"	19/64"
61320 AJ	17/32"	9/32"	1/4"	L193	23/32"	5/16"	13/32"
61320 AL	13/32"	21/64"	5/64"	L195	7/16"	1/4"	3/16"
61320 AM	1/4"	13/64"	3/64"	L217	1/2"	19/64"	13/64"
61420	1/2"	1/4"	1/4"	L218	17/32"	5/16"	7/32"
61420 A	1/4"	1/4"	1/4"	L266	17/32"	5/16"	7/32"
61420 B	33/64"	1/4"	17/64"	L290	23/32"	9/32"	7/16"
61420 C	17/32"	1/4"	9/32"	L293	7/16"	1/4"	3/16"
*61420 E	37/64"	-	1/4"	L313	17/32"	9/32"	1/4"
61420 F	7/16"	3/16"	1/4"	L326	3/4"	25/64"	23/64"
61420 H	7/8"	5/16"	9/16"	*L336	-	1/4"	-
**61420 J	1/4"	-	-	L412	59/64"	3/8"	35/64"
*61420 K	29/64"	1/16"	-	*L415	-	1/16"	-
*61420 L	13/32"	1/16"	-	L440	35/64"	5/16"	15/64"
61420 P	11/32"	11/64"	11/64"	L498 A	17/32"	1/4"	9/32"
61420 R	5/16"	7/32"	3/32"	L505	19/32"	5/16"	9/32"
61420 S	1"	1/4"	3/4"	L525	15/32"	1/4"	7/32"
61420 T	35/64"	11/32"	13/64"	L556	5/8"	5/16"	5/16"
61420 U	3/4"	3/8"	3/8"	*L637	21/32"	11/32"	5/16"
61420 V	25/64"	1/16"	21/64"	*L653	-	-	3/32"
*61420 AD	1/2"	-	3/16"	L943	7/16"	1/4"	3/16"
61420 AE	37/64"	5/16"	17/64"	K51683	33/64"	17/64"	1/4"
*61420 AF	7/16"	-	1/16"	K51687	15/32"	1/4"	7/32"

* ℄ of needle to spring guide.

** Needle penetrates .074 inch from right edge of presser foot.

† Adjustable guide, 1/32 to 3/8 inch from ℄ of needle to right side.

NUMERICAL INDEX OF PARTS

<u>Part No.</u>	<u>Page No.</u>	<u>Part No.</u>	<u>Page No.</u>	<u>Part No.</u>	<u>Page No.</u>	<u>Part No.</u>	<u>Page No.</u>
L3	67	109	27,	L380	55	660-221	25, 33
L11	67			L385	65	660-225	31
L17	51	L122	67	L390	69	660-240	75
L17 A	55	L122 A	63	L391	39	660-254	25
18	77	L123	67	L394	65	660-254 A	27
18-768	25	L125	71	405-571	53	660-254 B	27
L18	71	L127	69			660-254 C	29
20	63			L408	57	660-254 D	29
HS24 C	27	134	75	L412	47	660-269	29
25 B	75	L139	57	413	75	660-269 A	27
25 C	75	L154	67	L415	51	660-283 A	29
25 CC	75	L158	47	421 H	29	660-456	25, 29
G26	75	L158 A	63			666-109	25
T26	59, 75	L160	71	L437	41	666-166	77
27-527 Blk.	33	L179	65	L438	41	666-181	33
27-534 Blk.	25	L180	65	L440	47	666-182	33
28 B	45, 75	L184	71	L464	69	666-186	29
L28	41	L186	69	L471	67	666-191	25
L29	41	187 A	75	L473	57	666-194	25
T29	63, 75	L193	55	L489	67	666-198	25
L30	57	L195	49	L495	69	666-200	25
L32	69	L196	65	L498 A	47	666-212	25
L39 A	49	L205	53	L501	69	666-214	25
50-982 Blk.	25	L212	71	L502	69	666-221	25
L54	41	L217	53	L503	69	666-231	25
L55	41	L218	49	L505	55	666-237	25
57 WB	45	L220	55			666-238	25
57 WC	45	222 D	27	L516	65	666-261	25
57 WD	45	L222	41	L524	69	666-262	25
L64	49	L223	41	L525	47	666-273	25, 29
L67	71	226	75	L526	69	L683	63
CO67 B	25	L229	71	L529	57	L688	67
		230	29	531	75	719	31
69 S	75	L234	69	L531	69	L719	69
69 FD	77			L549	39	L727	57
L72	49	L250	69	L550	39	L748	57
73 A	45, 75	L265	67	L556	53	L756	57
73 C	29, 31, 45, 75	L266	49	L564	65	L763	67
HA73 B	33, 45, 75	L289	71	L566	55	L766	71
L77	71	L290	55	L567	69	L768	53
L81	71	L292	57	L579	35	L774	63
L82 A	49	L293	47	L580	35	L775	57
L86 A	47	L302	65	L582	57	L829	69
88	31, 33, 59, 77	L310	71	L599	69	L836	57
88 A	75	L313	55	604	45, 75	L868	57
88 D	31	L314 A	63	605	45, 75	L869	69
89	31, 33	L326	49	L610	67	L889	71
L89	71	L327	65			L900	69
90	27, 31, 75	SC331	77	L631	65	L909	71
91	59, 75	L336	51	L637	51	L916	43
91 A	27, 59	L355	65	651-16	77	L917	71
93	75			652-16	27	L928	69
94	75	L366	71	652 B-20	29	L943	47
L95	49	L367	71	L653	51	1230 B	63
96	27	L368	53	660-168	77	1741 A	63
L96	65	L369	39	660-204	27	1741 B	63
L97	75	376	27, 75	660-215	59		
100 B	75	L377	71	660-219 A	27	6042 A	25,
		L378	65	660-219 B	29	9937	29
		L379	69	660-219 D	59	11635 B	25
						12865	33
						12935 A	31

From the library of: Diamond Needle Corp

NUMERICAL INDEX OF PARTS

<u>Part No.</u>	<u>Page No.</u>	<u>Part No.</u>	<u>Page No.</u>	<u>Part No.</u>	<u>Page No.</u>	<u>Part No.</u>	<u>Page No.</u>
12957 E	63	22565 C	29			K51687	49
15037 A	31	22565 E	75	22846 Q	77	K51688	65
15872 F	29	22565 M	33	22848	75	K51689	65
21104 B	75	22569 B	25	22863 B	27	K51699	71
21114 A	75	22569 H	33	22874 F	29	51930	63
21130 A	75	22570	27, 29, 75			52130 D	59
21201	75	22570 A	27, 77	22878	77	52130 F	59
21202	75	22571 F	27	22884	29, 31	53678 N	33
21203	75	22574 C	29	22890 A	29	56393 AA	25
21204	75	22585	75	22894 C	31, 59	61203	73
21205 A	75	22585 A	75, 77	22894 E	27	61203 A	73
21207	75	22585 C	59	22894 F	59	61203 B	71
21208	75	22586	31	22894 J	31	61203 C	71
21208 A	75	22597 E	27	22894 R	33	61203 D	71
21227 BY	77	22597 F	77	22894 U	29	61205 A	37
21227 BZ	77			22894 V	29	61205 B	39
21233 DC	75	22644 K-64	27			61205 C	35, 37
21236	75	22649 F	75	23168 S	67	61205 D	35
21240 A	59	22650 AE	77	23278 K	71	61205 E	39
21240 B	59	22650 CB	75	23510	65	61205 CA	37
21240 C	59	22650 CE	75	23510 A	65	61210 B	33
21240 D	59	22651 CD	75	29126 DD	31	61212	33, 77
21240 E	59	22653 D-6	31	29474 P	33	61216	33
21240 F	59	22711	75			61216 N	33
21261 M	75	22712 G	29	29475 AR	27	61220	47
21351	75	22712 N	75	29475 AS	27	61220 B	57
21351 A	75	22716 A	31, 33, 75	29475 BC	29	61220 C	57
21388 AV	77	22716 B	33	29475 BH	29	61220 D	57
21390 BE	45	22716 H	33			61220 G	53
21393 L	77	22726	75	29480 CS	45	61220 H	55
21393 N	77	22733 D	27	29480 CY	59	61220 J	49
21393 R	77	22735	75	29486 L	29	61220 K	47
21393 S	77	22738	75	35730 C	61	61220 L	57
21629	25	22742	27	35730 D	61	61220 M	57
21657 E	63	22743	33, 59	35857 R	33	61220 N	51
21661 N	77	22757 D	29	39198 D	33, 59	61220 P	49
21661 R	77	22758 B	29	51430 F	63	61220 Q	47
21663 D	77	22760 A	75	K51606	73	61220 R	53
21664	77	22765	59	K51619	65	61220 S	47
21665 E	77	22766	27	K51621	65	61220 T	53
21665 J	77	22768	31	K51622	67	61220 V	53
21745 E	75	22768 A	29	K51623	73	61220 W	47
22504 A	27	22775	29, 75	K51624	71	61220 AA	57
22513	75	22775 A	31	K51625	73	61220 AB	53
22516	27	22784 E	29	K51626	71	61220 AC	51
22516 B	33	22784 K	25	K51645	55	61224 B	39
22528	27, 31, 75	22798	75	K51649	67	61224 C	35, 37
22539 P	27	22799 B	75	K51650	67	61224 D	43
22547 A	75	22799 H	75	K51655	71	61224 E	39
22551	75	22801	75	K51659	73	61224 F	35
22551 A	75	22805	27	K51666	71	61230	63
22560 G	27	22815	27	K51667	71	61230 A	63
22561	75	22817 A	29	K51668	67	61230 B	63
22562	27	22818	59, 75	K51669	67	61230 C	63
22562 B	29	22819	33	K51670	65	61230 F	61
22564	25, 29	22825	75	K51671	71	61230 J	63
22564 B	27, 45	22839	29	K51672	67	61230 L	61
22564 E	33	22840 A	75	K51677	71	61230 M	61
22564 F	33	22845 B	59	K51681	65	61230 S	63
22564 H	31	22845 K	31	K51683	53	61230 U	63

From the library of: Diamond Needle Corp

NUMERICAL INDEX OF PARTS

Part No.	Page No.	Part No.	Page No.	Part No.	Page No.	Part No.	Page No.
61230 V.....	61	61320 AJ.....	47	61377 Y.....	77	61420 AF.....	51
61230 W.....	61	61320 AL.....	49	61378.....	77	61420 AG.....	51
61230 X.....	63	61320 AM.....	55	61392 F-9.....	27	61420 AH.....	51
61230 AK.....	63	61324.....	41			61420 AJ.....	51
61231.....	63	61324 A.....	37			61420 AK.....	51
61231 A.....	63	61324 B.....	43	61405 C.....	35	61420 AM.....	51
		61324 C.....	37	61405 G.....	37	61420 AN.....	47
61236.....	31	61324 D.....	37	61405 H.....	39	61420 AP.....	47
61236 G.....	31	61324 E.....	43	61405 J.....	35	61420 AR.....	47
61255.....	29	61324 F.....	43	61405 K.....	39	61420 AS.....	47
61256 G.....	29	61324 J.....	35	61405 L.....	41, 43	61420 AT.....	47
61257 G.....	59	61324 L.....	35	61405 M.....	39	61420 AU.....	55
61273.....	27	61324 N.....	41	61405 N.....	37	61420 AV.....	49
61292 C.....	27	61324 Q.....	35	61405 R.....	41	61420 AW.....	49
61293 N.....	25	61324 R.....	37	61405 S.....	37	61420 AX.....	49
61303.....	71	61324 U.....	39	61405 T.....	43	61420 AY.....	49
61303 A.....	71	61330.....	63	61405 U.....	43	61420 AZ.....	49
61303 B.....	71	61330 B.....	45, 63	61405 X.....	39	61420 BB.....	53
61303 C.....	71	61330 C.....	61	61405 Y.....	35	61420 BC.....	55
61303 D.....	63	61330 E.....	63	61405 Z.....	39	61420 BD.....	55
61303 E.....	73	61330 F.....	63	61405 AA.....	43	61420 BE.....	55
61305.....	41	61330 L.....	61	61405 AB.....	43	61420 BG.....	53
61305 A.....	37	61330 M.....	61	61405 AC.....	45	61420 BH.....	51
61305 B.....	43	61330 N.....	63	61405 AD.....	45	61420 BJ.....	49
61305 C.....	37	61330 P.....	63	61405 AE.....	43	61420 BK.....	49
61305 D.....	37	61330 Q.....	63	61405 AH.....	41	61420 BN.....	55
61305 E.....	43	61330 R.....	61	61405 AN.....	39	61420 BR.....	47
61305 F.....	37	61330 T.....	61	61411 A.....	33	61420 BT.....	47
61305 G.....	43	61330 V.....	61	61413 E.....	33	61420 BU.....	49
61305 K.....	35	61330 W.....	61	61413 F.....	33	61420 BV.....	49
61305 M.....	35	61330 Y.....	61	61413 G.....	33	61420 BW.....	45
61305 N.....	41	61330 Z.....	61	61414 A.....	27	61420 BY.....	49
61305 Q.....	35	61330 AB.....	61	61414 C.....	33	61420 CL.....	53
61305 S.....	35	61330 AC.....	63	61415.....	33	61420 CM.....	47
61305 T.....	37	61330 AD.....	61	61415 A.....	33	61421 B.....	29
61305 U.....	39	61330 AE.....	61	61417 E.....	29	61421 C.....	29
61320.....	55	61330 AF.....	61	61420.....	47	61421 D.....	29
		61330 AG.....	61	61420 A.....	47	61421 E.....	29
61320 C.....	55	61330 AH.....	63	61420 B.....	47	61421 F.....	29
61320 E.....	51	61330 AJ.....	61	61420 C.....	49	61421 G.....	29
61320 F.....	51	61330 AK.....	63	61420 E.....	51	61424 C.....	35
61320 K.....	53	61330 AL.....	61	61420 F.....	53	61424 G.....	37
61320 L.....	55	61330 AM.....	61	61420 H.....	55	61424 H.....	39
61320 M.....	53	61330 AN.....	61	61420 J.....	53	61424 J.....	35
61320 N.....	51	61330 AP.....	63	61420 K.....	51		
61320 P.....	53	61330 AR.....	61	61420 L.....	51	61424 L.....	41
61320 Q.....	49	61330 AS.....	61	61420 M.....	55	61424 M.....	39
61320 R.....	49	61330 AU.....	61	61420 N.....	55	61424 N.....	37
61320 S.....	49	61330 AV.....	63	61420 P.....	53	61424 R.....	41
61320 U.....	51	61330 AW.....	61	61420 R.....	53	61424 S.....	37
61320 V.....	51	61330 AX.....	61	61420 S.....	53	61424 T.....	43
61320 X.....	53	61336 U.....	31	61420 T.....	55	61424 U.....	43
61320 AA.....	49	61336 Y.....	31	61420 U.....	53	61424 X.....	39
61320 AB.....	51	61351 C.....	29, 33	61420 V.....	53	61424 Y.....	35
61320 AC.....	53	61356.....	29	61420 W.....	57	61424 Z.....	43
61320 AD.....	49	61360 G.....	31	61420 X.....	57	61424 AA.....	43
61320 AE.....	51	61375.....	77	61420 Y.....	57	61424 AB.....	43
61320 AF.....	49			61420 Z.....	57	61424 AC.....	45
61320 AG.....	47			61420 AC.....	57	61424 AD.....	45
61320 AH.....	47			61420 AD.....	51	61424 AE.....	43
				61420 AE.....	55	61424 AH.....	41

From the library of: Diamond Needle Corp

NUMERICAL INDEX OF PARTS

Part No.	Page No.	Part No.	Page No.	Part No.	Page No.	Part No.	Page No.
61424 AM	39	61444	33	61492 G	27	63452 A	29
61430 A	63	61449 B	31	61492 H	27	63453	27
61430 B	63	61449 S	31	61493 A	25	63453 C	29
61430 C	61	61449 T	27	61493 C	25	63455	29
61430 M	63	61449 U	27	61494 D	25	63457 B	59
61430 N	63	61449 V	27	61494 E	25	63457 C	59
61430 P	63	61449 X	27	61494 F	25	63457 D	59
61430 S	61	61449 Y	27	61494 H	25	63457 E	59
61430 T	61	61451	29	61494 K	25	63457 F	59
61430 Y	61	61451 A	29	61494 L	25	63457 G	59
61430 AA	63	61451 B	29	61494 N	25	63457 J	29
61430 AB	61	61451 D	29	61494 R	27	63457 R	29
61430 AC	61	61454 A	29	61496 C	33	63466	29
61430 AD	45	61454 B	29	61496 D	33	63470	27
61430 AE	45	61454 C	25	61496 E	33	63470 A	27
61430 AF	45	61455	29	61496 F	33	63470 B	27
61430 AG	45	61457 B	29	61496 G	33	63471	45
61430 AH	45	61457 K	25	61496 J	33	63471 A	45
61430 AJ	45	61458 G	29	61496 K	33	63474 A	77
61430 AK	45	61458 FA	29	61496 L	33	63476	77
61430 AL	45	61459 C	29	61496 M	33	63476 A	77
61430 AN	45	61460	29	61496 N	33	63476 B	77
61430 AP	45	61460 A	31	61496 P	25, 33	63476 C	77
61430 AS	61	61460 B	29	61496 S	25	63482 A	27
61430 AT	63	61467	29	61496 V	33	63492	27
61430 BB	63	61468 B	29	63402 B	27	63493	25
61430 CA	45	61468 D	29	63407	33	63493 H	25
61430 CB	45	61468 E	29	63407 A	33	63493 J	25, 29
61432 B	25	61468 F	29	63408	33	63494	25
61432 C	25	61470 C	27	63414	33	63494 A	27
61432 E	25	61470 D	27, 77	63420 D	45	63494 B	27
61432 H	31	61471 A	27	63430 C	59	63494 C	25
61432 J	31	61471 B	27	63430 D	59	63494 D	25
61434 G	31	61471 D	25	63432	33	63494 K	25, 27
61437 A	31	61471 F	25	63432 E	25	63494 N	25
61437 B	31	61477 M	77	63433 A	31	63496 B	33
61437 L	31	61482 G	27	63434 C	31	K67092	59
61437 M	31	61482 H	27	63435 A	31	K67093	59
61437 N	31	61482 J	27	63439 A	31	K67096	59
61438 B	31	61490 B	25	63439 AL	31	79077	25
61440	33	61490 D	25	63443	31	92201	77
61441	25	61492 E	27	63445	75		
61441 A	25	61492 F	27	63451	27		

From the library of: Diamond Needle Corp

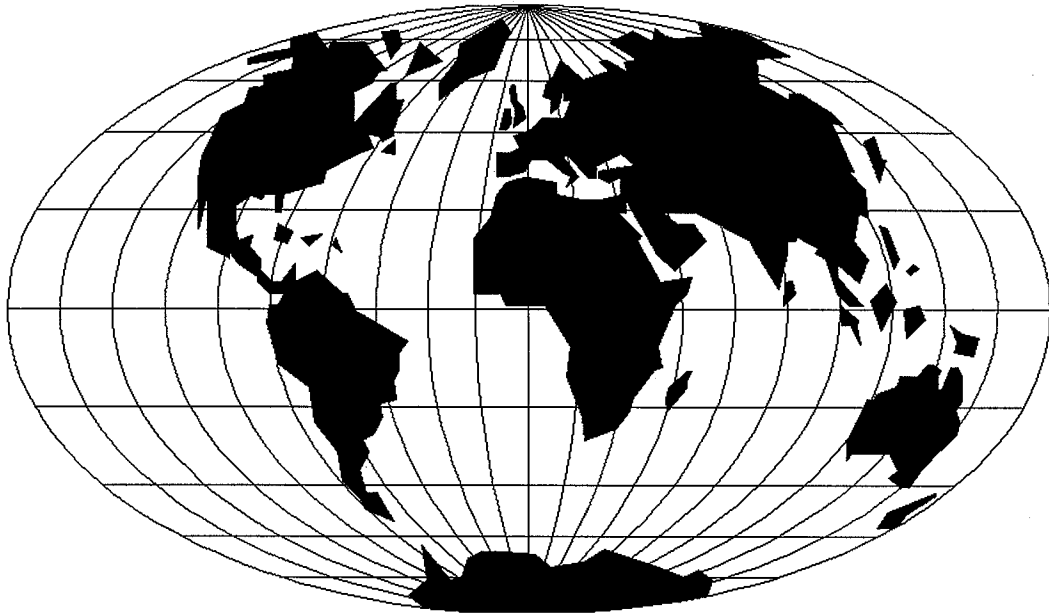

WORLDWIDE SALES AND SERVICE

Union Special Corporation maintains sales and service facilities throughout the world. These offices will aid you in the selection of the right sewing equipment for your particular operation. Union Special Corporation representatives and service technicians are factory trained and are able to serve your needs promptly and efficiently. Whatever your location, there is a qualified representative to serve you.

Corporate Office: One Union Special Plaza
Huntley, IL 60142
Phone: 847•669•5101
Fax: 847•669•4454

European Distribution Center: Union Special GmbH
Raiffeisenstrasse 3
D-71696 Möglingen, Germany
Tel: 49•07141•247•0
Fax: 49•07141•247•100

Brussels, Belgium
Charlotte, N.C.
Hong Kong, China
Huntley, IL
Leicester, England
Lille, France
Miami, FL
Milan, Italy
Möglingen, Germany
Montreal, Quebec
Osaka, Japan
Santa Fe Springs, CA
Suwanee, GA
Wayne, NJ

Other Representatives throughout all parts of the world.



Union Special
INDUSTRIAL SEWING EQUIPMENT